

CRISTINA

IN BAGNO



INDEX



INOX LINES	P. 04
CONTEMPORARY LINES	P. 58
CLASSIC LINES	P. 224
SHOWER & BATH SYSTEMS	P. 272
CRISTINA SYSTEM	P. 326
WATER SYSTEMS	P. 334
ACCESSORIES	P. 396

INOX LINES

GAMMA DI PRODOTTI DALL' ANIMA "GREEN": L' INOX ABBINA FUNZIONALITÀ ED ESTETICA.

_THE "GREEN" SOUL OF THIS LINE IS COMBINED WITH FUNCTIONALITIES AND AESTHETICS.

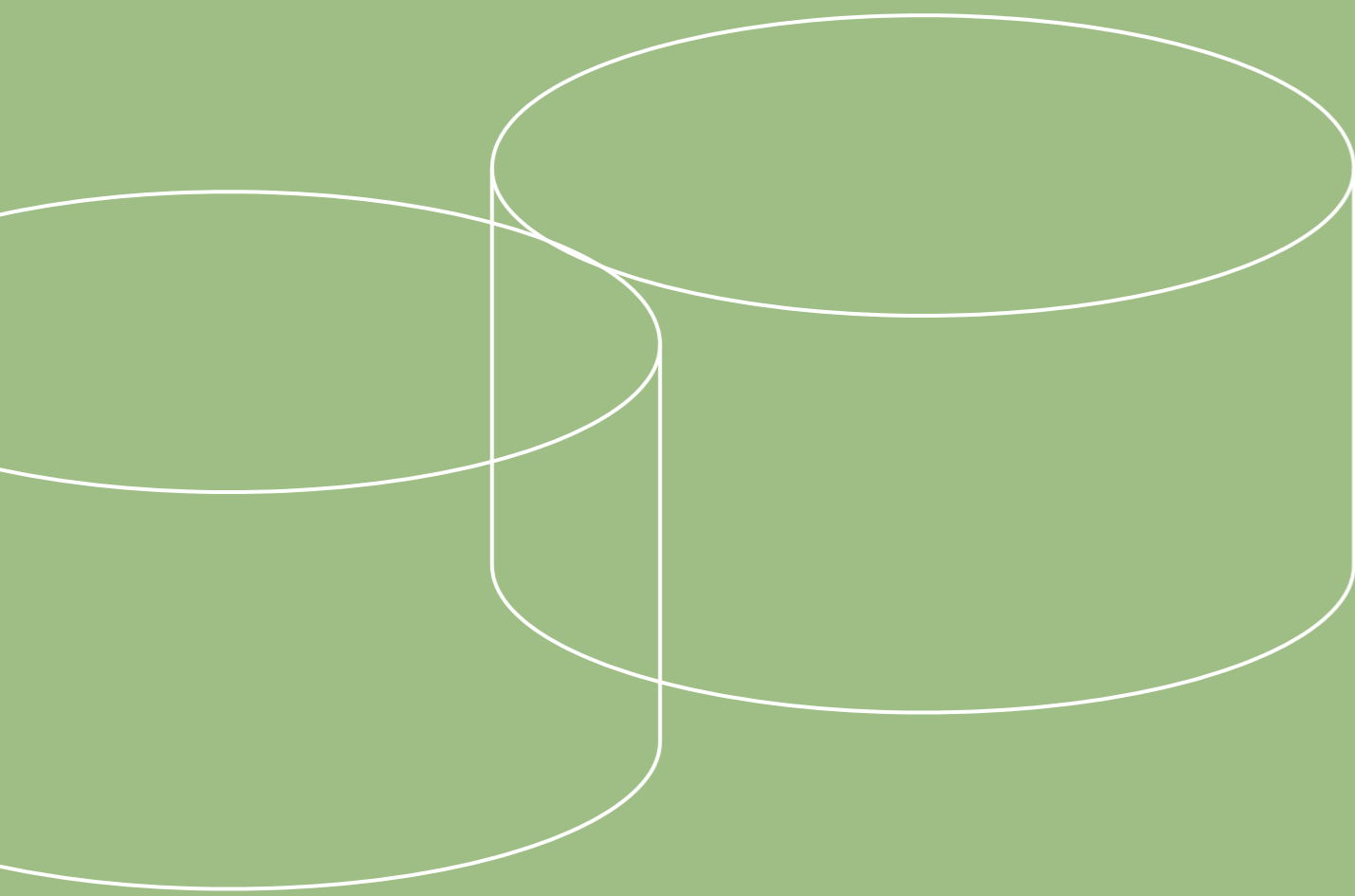

IX	p. 06
PIX	p. 10
RX	p. 14
SX	p. 18
UNIX	p. 26
OUTDOOR / INDOOR SHOWERS	p. 30
WC JET	p. 34
THE RANGE Technical Specifications	p. 36

IX

Si ispira nelle forme alle antiche fontane a muro della tradizione italiana ed è interamente realizzata in acciaio inox AISI 316 L, lega austenitica di altissima qualità. Elementi che fanno della IX una serie capace di esprimere al meglio la filosofia del nostro brand: design essenziale e impiego dei materiali migliori.

La IX è dotata di miscelatore a levetta con cartuccia classica.

_In look reminiscent of the wall fountains of the Italian tradition it is entirely made of stainless steel AISI 316 L, an austenitic alloy of very high quality. These figures are the strength of IX line, they highlight properly the identity of the brand: essential design and best materials. The IX line offers the handle mixers with stick and single level cartridge.

INOX LINES CRISTINA



IX 222



IX 227



IX 102

PIX

Linee geometriche primarie si intersecano creando una sofisticata eleganza high-tech. Il superfluo è stato eliminato in favore dell'essenzialità. L'inox esprime l'anima "green" della serie PIX. Atossico e riciclabile, l'acciaio inox è resistente e duraturo rendendo questi rubinetti praticamente eterni.

_Basic geometric lines merge creating a high-tech sophisticated elegance. The surplus has been eliminated in favor of essentiality. The choice of stainless steel conveys the green soul of the PIX series. Non-toxic and recyclable, stainless steel is strong and durable making these taps virtually eternal.





PX 220



PX 102

RX

Supportata da una cartuccia progressiva, la serie RX permette di regolare con estrema precisione la temperatura dell'acqua con la semplice rotazione della maniglia, da calda a fredda con una rotazione di 180°.

Nata come "alter ego" della IX, ne condivide il materiale e le forme pulite.

Equipped with a progressive cartridge, the RX Series enables to regulate precisely the water temperature with a simple rotation of the handle from cold to hot, with a 180° from first position. Created as the "alter ego" of the IX, sharing the same material and the same clean lines.

RX 232



RX 179



SX

—
design MAKIO HASUIKE

Caratterizzata da una silhouette unica e da una smussatura conica che nasconde l'aeratore. Ideale per ambienti domestici e contract, la collezione offre soluzioni per creare un ambiente total look.

_The collection is characterized by a unique silhouette and a conical bevel that hides the aerator. Ideal for domestic and contract requirements, the collection offers solutions to create a total look environment.

INOX LINES CRISTINA



SX 220



SX 242



SX 225



SX 281



SX 281



SX 131

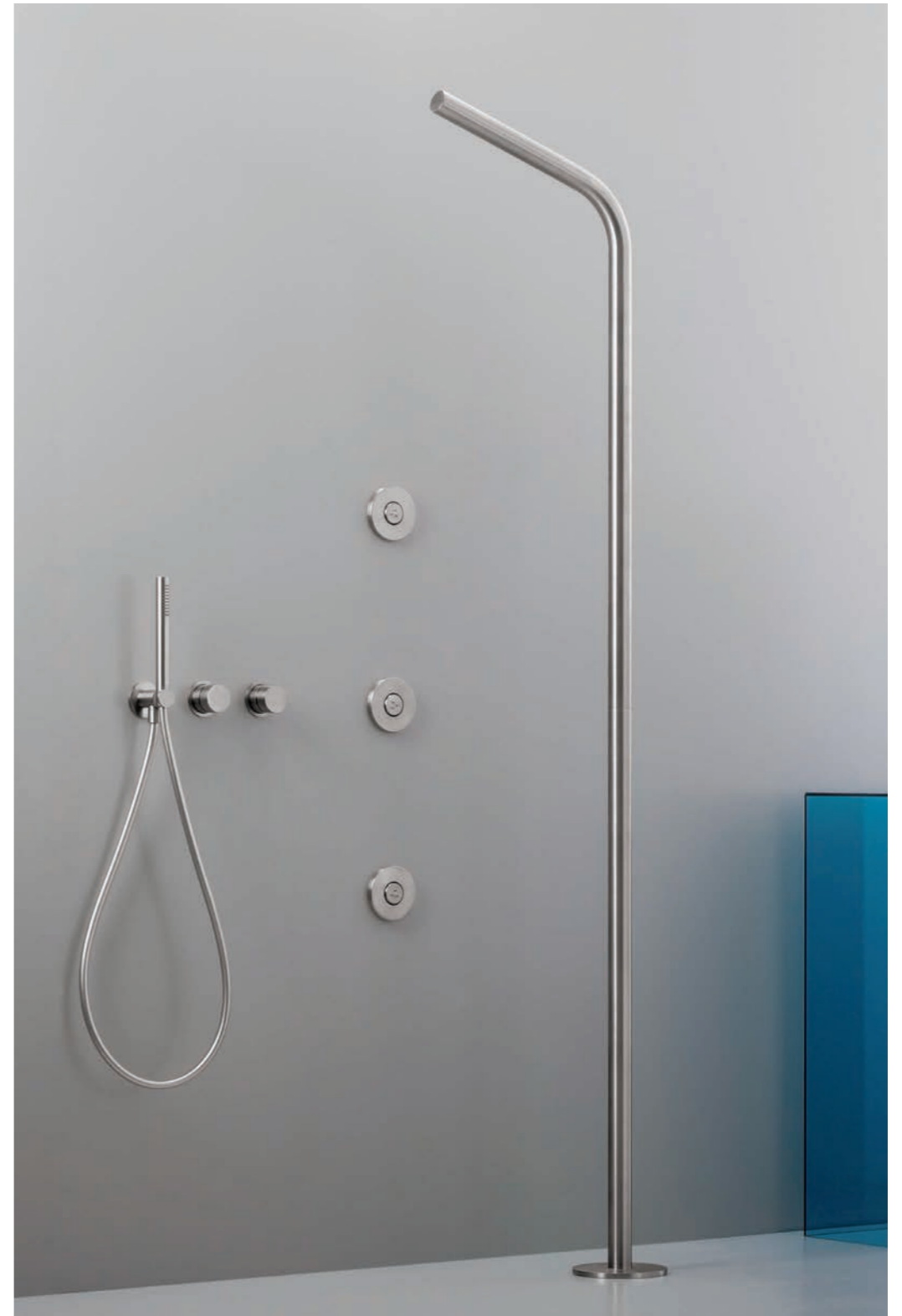

SX 507 + SX 603

UNIX

Così come lo Yin e lo Yang la serie UNIX è stata concepita per fondere spiriti opposti e complementari: estetica e funzionalità, spigoli e curve, accuratezza e semplicità. Un connubio che esprime purezza, leggerezza e precisione, mentre l'inox incarna l'infinito.

_Just like Yin and Yang the UNIX series is designed to mix opposite and complementary souls: aesthetics and functionality, edges and curves, accuracy and simplicity. A combination expressing purity, lightness and precision, while stainless steel embodies the infinite.



UX 256



UX 222

OUTDOOR/ INDOOR SHOWERS

Elementi d'arredo di altissima qualità, caratterizzati da linee sinuose e contemporanee, capaci di offrire momenti di autentico relax a bordo piscina, sul terrazzo o in giardino. Realizzate in acciaio inox AISI 316L per garantire la massima resistenza nel tempo, sono ideali per spazi wellness pubblici e privati. Possono essere applicate anche in ambienti interni dallo stile moderno, come loft industriali o aree SPA.

_High quality furnishing elements, characterized by sinuous and contemporary lines, perfect to enjoy moments of authentic relaxation by the pool, on the terrace or in the garden.

Produced with AISI 316L stainless steel to provide high resistance to any kind of chemical agent or corrosion, they are ideal for both public and private wellness areas, and also for modern interiors such as industrial lofts or SPA areas.

archiproducts
DESIGN AWARDS
WINNER 2016



WX 524



WX 514

WC JET



WJ 676 28



IX the range

LAVABO - BIDET
_WASHBASIN - BIDET



CRISTINA

AISI 316 L



IX 220

Miscelatore monocomando REGULAR per lavabo con scarico Up&Down da 1"1/4

_Basin mixer REGULAR with 1"1/4 Up&Down waste



IX 227

Miscelatore monocomando MEDIUM per lavabo con scarico Up&Down da 1"1/4

_Basin mixer MEDIUM with 1"1/4 Up&Down waste



IX 222

Miscelatore monocomando TALL per lavabo con scarico Up&Down da 1"1/4

_Basin mixer TALL with 1"1/4 Up&Down waste



IX 256

Set da esterno miscelatore monocomando lavabo REGULAR per CS 200 (comando destro) - CS 201 (comando sinistro) con scarico Up&Down da 1"1/4

_Wall mounted basin mixer REGULAR external parts for CS 200 (right side) - CS 201 (left side) with 1"1/4 Up&Down waste

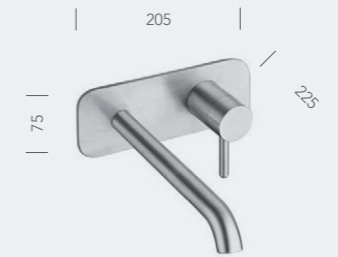

IX 258

Set da esterno miscelatore monocomando lavabo LARGE per CS 200 (comando destro) - CS 201 (comando sinistro) con scarico Up&Down da 1"1/4

_Wall mounted basin mixer LARGE external parts for CS 200 (right side) - CS 201 (left side) with 1"1/4 Up&Down waste



IX 257

Set da esterno miscelatore monocomando lavabo REGULAR per CS 200 (comando destro) - CS 201 (comando sinistro) con scarico Up&Down da 1"1/4 e piastra in metallo

_Wall mounted basin mixer REGULAR external parts for CS 200 (right side) - CS 201 (left side) with 1"1/4 Up&Down waste and metal plate



IX 290

Set da esterno per miscelatore monocomando progressivo lavabo a pavimento CS 290 con scarico Up&Down da 1"1/4

_Floor mounted progressive basin mixer external parts for CS 290 with 1"1/4 Up&Down waste



IX 241

Set completo per miscelatore monocomando lavabo REGULAR da incasso con scarico Up&Down da 1"1/4

_Complete wall mounted basin mixer REGULAR with 1"1/4 Up&Down waste



IX 242

Set completo per miscelatore monocomando lavabo LARGE da incasso con scarico Up&Down da 1"1/4

_Complete wall mounted basin mixer LARGE with 1"1/4 Up&Down waste

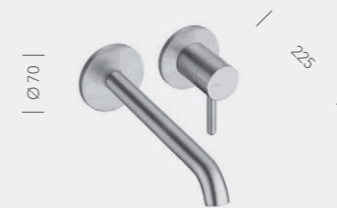

IX 259

Set da esterno miscelatore monocomando lavabo LARGE per CS 200 (comando destro) - CS 201 (comando sinistro) con scarico Up&Down da 1"1/4 e piastra in metallo

_Wall mounted basin mixer LARGE external parts for CS 200 (right side) - CS 201 (left side) with 1"1/4 Up&Down waste and metal plate



IX 320

Miscelatore monocomando per bidet con scarico Up&Down da 1"1/4

_Bidet mixer with 1"1/4 Up&Down waste

* interasse corpo - bocca

IX the range

VASCA - DOCCIA
_BATH - SHOWER



CRISTINA

AISI 316 L

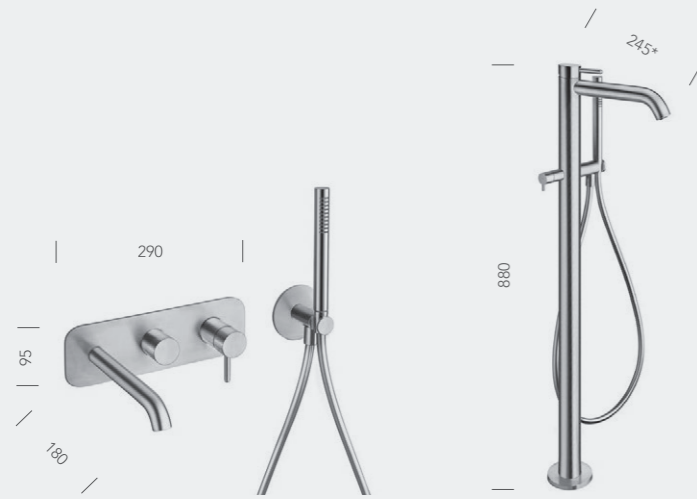

IX 102 | 103

Set completo per miscelatore monocomando doccia/vasca CS100 (comando destro) - CS 101 (comando sinistro) con deviatore 2/3 uscite, doccetta anticalcare, flessibile LONG LIFE e piastra in metallo

_Complete concealed bath/shower mixer CS100 (right side) - CS 101 (left side) with 2/3 outlet diverter, anti-lime hand shower, LONG LIFE flexible hose and metal plate

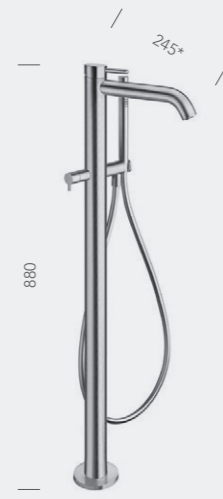

IX 189

Set da esterno per miscelatore monocomando vasca a pavimento CS 290 con flessibile LONG LIFE e doccetta anticalcare con miscelazione indipendente

_Floor mounted bath mixer external parts for CS 290 with LONG LIFE flexible hose and anti-lime hand shower with independent mixing



XX 142 | 143

Miscelatore termostatico per bordo vasca con deviatore 2/3 uscite

_Deck mounted thermostatic bath mixer with 2/3 outlets diverter



WJ 676

Miscelatore monocomando per wc/bidet esterno con flessibile LONG LIFE e doccetta con chiusura

_WC/bidet mixer valve with integrated douche handset holder and LONG LIFE flexible hose



IX 602

Set da esterno per miscelatore monocomando doccia/vasca CS 100 (comando destro) - CS 101 (comando sinistro) con deviatore 2 uscite, doccetta anticalcare, flessibile LONG LIFE

_Bath/shower mixer external parts for CS 100 (right side) - CS 101 (left side) with 2 outlet diverter, LONG LIFE flexible hose, anti-lime hand shower



RX 686

Set da esterno per miscelatore monocomando doccia/vasca CS 535

_Bath/shower mixer external parts for CS 535



RX 689

Set da esterno per miscelatore monocomando doccia/vasca CS 535 con deviatore 2 uscite

_Bath/shower mixer external parts for CS 535 with 2 outlet diverter

* interasse corpo - bocca

PIX the range



CRISTINA

AISI 316 L

LAVABO - BIDET
_WASHBASIN - BIDET

VASCA - DOCCIA
_BATH - SHOWER



PX 220

Miscelatore monocomando REGULAR per lavabo con scarico Up&Down da 1"1/4

_Basin mixer REGULAR with 1"1/4 Up&Down waste



PX 227

Miscelatore monocomando MEDIUM per lavabo con scarico Up&Down da 1"1/4

_Basin mixer MEDIUM with 1"1/4 Up&Down waste



PX 222

Miscelatore monocomando TALL per lavabo con scarico Up&Down da 1"1/4

_Basin mixer TALL with 1"1/4 Up&Down waste

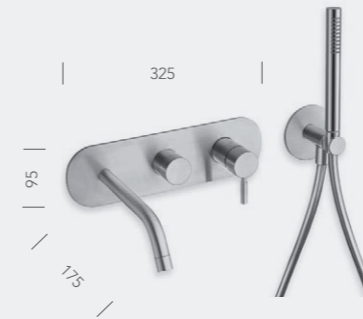

PX 102 | 103

Set completo per miscelatore monocomando doccia/vasca CS100 (comando destro) - CS 101 (comando sinistro) con deviatore 2/3 uscite, doccetta anticalcare, flessibile LONG LIFE e piastra in metallo

_Complete concealed bath/shower mixer CS100 (right side) - CS 101 (left side) with 2/3 outlet diverter, anti-lime hand shower, LONG LIFE flexible hose and metal plate



XX 142|143

Miscelatore termostatico per bordo vasca con deviatore 2/3 uscite

_Deck mounted thermostatic bath mixer with 2/3 outlets diverter



PX 602 | 603

Set da esterno per miscelatore monocomando doccia/vasca CS 100 (comando destro) - CS 101 (comando sinistro) con deviatore 2/3 uscite, doccetta anticalcare, flessibile LONG LIFE

_Bath/shower mixer external parts for CS 100 (right side) - CS 101 (left side) with 2/3 outlet diverter, LONG LIFE flexible hose, anti-lime hand shower

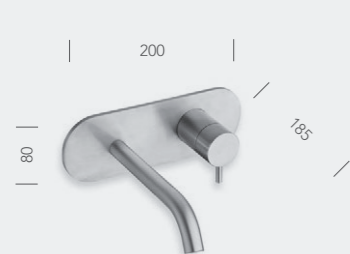

PX 256

Set da esterno miscelatore monocomando lavabo REGULAR per CS 200 (comando destro) - CS 201 (comando sinistro) con scarico Up&Down da 1"1/4

_Wall mounted basin mixer REGULAR external parts for CS 200 (right side) - CS 201 (left side) with 1"1/4 Up&Down waste



PX 320

Miscelatore monocomando per bidet con scarico Up&Down da 1"1/4

_Bidet mixer with 1"1/4 Up&Down waste



PX 686

Set da esterno per miscelatore monocomando doccia CS 535

_Shower mixer external parts for CS 535



PX 689

Set da esterno per miscelatore monocomando doccia/vasca CS 535 con deviatore 2 uscite

_Bath/shower mixer external parts for CS 535 with 2 outlet diverter



WJ 676

Miscelatore monocomando per wc/bidet esterno con flessibile LONG LIFE e doccetta con chiusura

_WC/bidet mixer valve with integrated douche handset holder and LONG LIFE flexible hose

* interasse corpo - bocca

RX the range

LAVABO - BIDET
_WASHBASIN - BIDET



CRISTINA

AISI 316 L



RX 210

Miscelatore monocomando REGULAR per lavabo con scarico Up&Down da 1"1/4

_Basin mixer REGULAR with 1"1/4 Up&Down waste



RX 217

Miscelatore monocomando MEDIUM per lavabo con scarico Up&Down da 1"1/4

_Basin mixer MEDIUM with 1"1/4 Up&Down waste



RX 212

Miscelatore monocomando TALL per lavabo con scarico Up&Down da 1"1/4

_Basin mixer TALL with 1"1/4 Up&Down waste

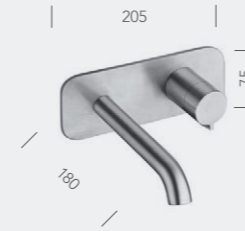

RX 256

Set da esterno miscelatore monocomando lavabo REGULAR per CS 200 (comando destro) - CS 201 (comando sinistro) con scarico Up&Down da 1"1/4

_Wall mounted basin mixer REGULAR external parts for CS 200 (right side) - CS 201 (left side) with 1"1/4 Up&Down waste

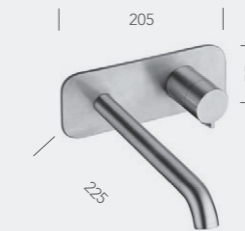

RX 258

Set da esterno miscelatore monocomando lavabo LARGE per CS 200 (comando destro) - CS 201 (comando sinistro) con scarico Up&Down da 1"1/4

_Wall mounted basin mixer LARGE external parts for CS 200 (right side) - CS 201 (left side) with 1"1/4 Up&Down waste



RX 257

Set da esterno miscelatore monocomando progressivo lavabo REGULAR per CS 200 (comando destro) - CS 201 (comando sinistro) con scarico Up&Down da 1"1/4

_Progressive wall mounted basin mixer REGULAR external parts for CS 200 (right side) - CS 201 (left side) with 1"1/4 Up&Down waste



RX 280

Set da esterno per miscelatore monocomando progressivo lavabo a pavimento CS 290 con scarico Up&Down da 1"1/4

_Floor mounted progressive basin mixer external parts for CS 290 with 1"1/4 Up&Down waste



RX 231

Set completo per miscelatore monocomando lavabo REGULAR da incasso con scarico Up&Down da 1"1/4

_Complete wall mounted basin mixer REGULAR with 1"1/4 Up&Down waste



RX 232

Set completo per miscelatore monocomando lavabo LARGE da incasso con scarico Up&Down da 1"1/4

_Complete wall mounted basin mixer LARGE with 1"1/4 Up&Down waste



RX 259

Set da esterno miscelatore monocomando progressivo lavabo LARGE per CS 200 (comando destro) - CS 201 (comando sinistro) con scarico Up&Down da 1"1/4

_Progressive wall mounted basin mixer LARGE external parts for CS 200 (right side) - CS 201 (left side) with 1"1/4 Up&Down waste



RX 320

Miscelatore monocomando per bidet con scarico Up&Down da 1"1/4

_Bidet mixer with 1"1/4 Up&Down waste

* interasse corpo - bocca

RX the range



CRISTINA

AISI 316 L

VASCA - DOCCIA
_BATH - SHOWER

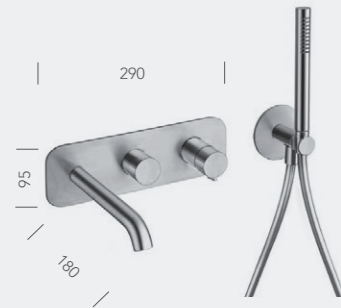

RX 102 | 103

Set completo per miscelatore monocomando doccia/vasca CS100 (comando destro) - CS 101 (comando sinistro) con deviatore 2 | 3 uscite, doccetta anticalcare, flessibile LONG LIFE e piastra in metallo

_Complete concealed bath/shower mixer CS100 (right side) - CS 101 (left side) with 2 | 3 outlet diverter, anti-lime hand shower, LONG LIFE flexible hose and metal plate

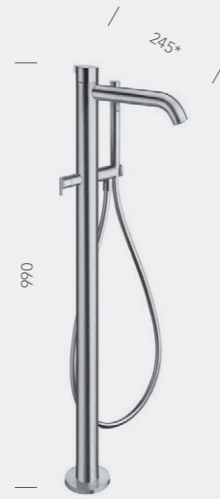

RX 179

Set da esterno per miscelatore monocomando vasca a pavimento CS 290 con flessibile LONG LIFE e doccetta anticalcare con miscelazione indipendente

_Floor mounted bath mixer external parts for CS 290 with LONG LIFE flexible hose and anti-lime hand shower with independent mixing



XX 142 | 143

Miscelatore termostatico per bordo vasca con deviatore 2/3 uscite

_Deck mounted thermostatic bath mixer with 2/3 outlets diverter



WJ 676

Miscelatore monocomando per wc/bidet esterno con flessibile LONG LIFE e doccetta con chiusura

_WC/bidet mixer valve with integrated douche handset holder and LONG LIFE flexible hose

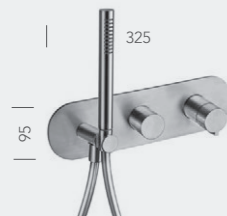

RX 602

Set da esterno per miscelatore monocomando doccia/vasca CS 100 (comando destro) - CS 101 (comando sinistro) con deviatore 2 uscite, doccetta anticalcare, flessibile LONG LIFE

_Bath/shower mixer external parts for CS 100 (right side) - CS 101 (left side) with 2 outlet diverter, LONG LIFE flexible hose, anti-lime hand shower



RX 686

Set da esterno per miscelatore monocomando doccia CS 535

_Shower mixer external parts for CS 535



RX 689

Set da esterno per miscelatore monocomando doccia/vasca CS 535 con deviatore 2 uscite

_Bath/shower mixer external parts for CS 535 with 2 outlet diverter

* interasse corpo - bocca

SX the range



CRISTINA

AISI 316 L

LAVABO - BIDET
_WASHBASIN - BIDET



SX 224

Miscelatore monocomando REGULAR per lavabo 2 fori con scarico Up&Down da 1"1/4

_2 hole basin mixer REGULAR with 1"1/4 Up&Down waste



SX 225

Miscelatore monocomando TALL per lavabo 2 fori con scarico Up&Down da 1"1/4

_2 hole basin mixer TALL with 1"1/4 Up&Down waste



SX 223

Set completo per miscelatore monocomando lavabo da incasso con bocca erogazione REGULAR da piano e scarico Up&Down da 1"1/4

_Complete wall mounted basin mixer with REGULAR standing spout and 1"1/4 Up&Down waste



SX 220

Miscelatore monocomando REGULAR per lavabo con scarico Up&Down da 1"1/4

_Basin mixer REGULAR with 1"1/4 Up&Down waste



SX 222

Miscelatore monocomando TALL per lavabo con scarico Up&Down da 1"1/4

_Basin mixer TALL with 1"1/4 Up&Down waste



SX 280

Set completo per miscelatore monocomando lavabo da incasso con bocca erogazione a pavimento e scarico Up&Down da 1"1/4

_Complete wall mounted basin mixer with floor mounted spout and 1"1/4 Up&Down waste



SX 226

Set completo per miscelatore monocomando lavabo da incasso con bocca erogazione TALL da piano e scarico Up&Down da 1"1/4

_Complete wall mounted basin mixer with TALL standing spout and 1"1/4 Up&Down waste



SX 205

Miscelatore bicomando REGULAR per lavabo 3 fori con scarico Up&Down da 1"1/4

_3 hole basin mixer REGULAR with 1"1/4 Up&Down waste



SX 207

Miscelatore bicomando TALL per lavabo 3 fori con scarico Up&Down da 1"1/4

_3 hole basin mixer TALL with 1"1/4 Up&Down waste



SX 281

Set completo per miscelatore monocomando lavabo da incasso con bocca erogazione a pavimento con accessorio girevole e scarico Up&Down da 1"1/4

_Complete wall mounted basin mixer with floor mounted spout with swivel accessory and 1"1/4 Up&Down waste



SX 257

Set da esterno miscelatore monocomando lavabo REGULAR per CS 200 (comando destro) - CS 201 (comando sinistro) con scarico Up&Down da 1"1/4

_Wall mounted basin mixer REGULAR external parts for CS 200 (right side) - CS 201 (left side) with 1"1/4 Up&Down waste



SX 259

Set da esterno miscelatore monocomando lavabo REGULAR per CS 200 (comando destro) - CS 201 (comando sinistro) con scarico Up&Down da 1"1/4

_Wall mounted basin mixer REGULAR external parts for CS 200 (right side) - CS 201 (left side) with 1"1/4 Up&Down waste

* interasse corpo - bocca

SX the range



CRISTINA

AISI 316 L

LAVABO - BIDET
_WASHBASIN - BIDET

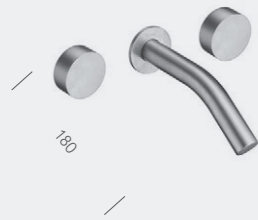

SX 242

Set da esterno miscelatore bicomando lavabo REGULAR per CS 233 (comandi laterali) - CS 234 (comando destro) con scarico Up&Down da 1"1/4

_Wall mounted basin mixer REGULAR external parts for CS 233 (side controls) - CS 234 (right side) with 1"1/4 Up&Down waste

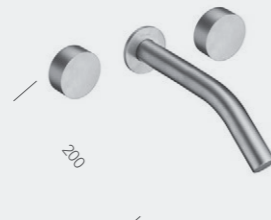

SX 243

Set da esterno miscelatore bicomando lavabo REGULAR per CS 233 (comandi laterali) - CS 234 (comando destro) con scarico Up&Down da 1"1/4

_Wall mounted basin mixer REGULAR external parts for CS 233 (side controls) - CS 234 (right side) with 1"1/4 Up&Down waste



SX 330

Miscelatore bicomando per bidet 3 fori con scarico Up&Down da 1"1/4

_3 hole bidet mixer with 1"1/4 Up&Down waste



SX 320

Miscelatore monocomando per bidet con scarico Up&Down da 1"1/4

_Bidet mixer with 1"1/4 Up&Down waste

*interasse corpo - bocca

SX the range



CRISTINA

AISI 316 L

VASCA - DOCCIA
_BATH - SHOWER

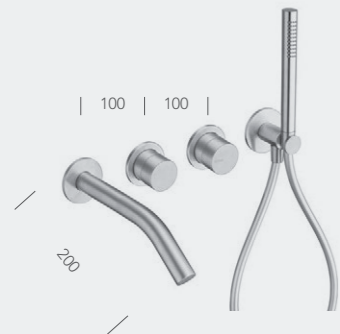

SX 102 | SX 103

Set da esterno per miscelatore monocomando doccia/vasca CS 100 (comando destro) - CS 101 (comando sinistro) con deviatore 2/3 uscite, doccetta anticalcare, flessibile LONG LIFE

_Bath/shower mixer external parts for CS 100 (right side) - CS 101 (left side) with 2/3 outlet diverter, LONG LIFE flexible hose, anti-lime hand shower



SX 121

Miscelatore monocomando per bordo vasca 3 fori con bocca erogazione a pavimento, doccetta anticalcare estraibile FOLLOW ME con miscelazione indipendente

_3 hole deck mounted bath mixer with floor mounted spout, pull-out anti-lime hand shower with independent mixing and FOLLOW ME



SX 123

Miscelatore monocomando per bordo vasca 3 fori con bocca erogazione a pavimento con accessorio girevole, doccetta anticalcare estraibile FOLLOW ME con miscelazione indipendente

_3 hole deck mounted bath mixer with floor mounted spout with swivel accessory, pull-out anti-lime hand shower with independent mixing and FOLLOW ME



SX 120

Miscelatore monocomando per bordo vasca 3 fori con doccetta anticalcare estraibile FOLLOW ME con miscelazione indipendente

_3 hole deck mounted bath mixer with pull-out anti-lime hand shower with independent mixing and FOLLOW ME



SX 132

Miscelatore monocomando per bordo vasca con 1 uscita da 1/2"

_Deck mounted bath mixer with 1 outlet 1/2"



XX 142 | XX 143

Miscelatore termostatico per bordo vasca con deviatore 2/3 uscite

_Deck mounted thermostatic bath mixer with 2/3 outlets diverter



SX 131

Set da esterno per miscelatore monocomando vasca CS 100 (comando destro) - CS 101 (comando sinistro) con deviatore 2 uscite, bocca erogazione a pavimento, doccetta anticalcare e flessibile LONG LIFE

_Bath mixer external parts for CS 100 (right side) - CS 101 (left side) with 2 outlet diverter, floor mounted spout, anti-lime hand shower, LONG LIFE flexible hose



SX 133

Set da esterno per miscelatore monocomando vasca CS 100 (comando destro) - CS 101 (comando sinistro) con deviatore 2 uscite, bocca erogazione a pavimento con accessorio girevole, doccetta anticalcare e flessibile LONG LIFE

_Bath mixer external parts for CS 100 (right side) - CS 101 (left side) with 2 outlet diverter, floor mounted spout with swivel accessory, anti-lime hand shower, LONG LIFE flexible hose



SX 124

Miscelatore monocomando per bordo vasca 4 fori con bocca erogazione, doccetta anticalcare estraibile FOLLOW ME con miscelazione indipendente

_4 hole deck mounted bath mixer with spout, pull-out anti-lime hand shower with independent mixing and FOLLOW ME



SX 507

Colonna doccia a pavimento monoacqua con sistema di fissaggio e alimentazione a terra. Da abbinare a miscelatore

_Floor mounted one-water shower column, ground fixing and water supply system. To combine with a mixer



SX 506

Colonna doccia a pavimento monoacqua con accessorio girevole, sistema di fissaggio e alimentazione a terra. Da abbinare a miscelatore

_Floor mounted one-water shower column with swivel accessory, ground fixing and water supply system. To combine with a mixer



SX 602 | SX 603

Set da esterno per miscelatore monocomando doccia/vasca CS 100 (comando destro) - CS 101 (comando sinistro) con deviatore 2/3 uscite, doccetta anticalcare, flessibile LONG LIFE

_Bath/shower mixer external parts for CS 100 (right side) - CS 101 (left side) with 2/3 outlet diverter, anti-lime hand shower, LONG LIFE flexible hose

* interasse corpo - bocca

SX the range

VASCA - DOCCIA
_BATH - SHOWER



CRISTINA

AISI 316 L

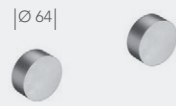

SX 618

Set da esterno per miscelatore bicomando doccia CS 233 (comandi laterali)

_Shower mixer external parts for CS 233 (side controls)



SX 638

Set completo per miscelatore monocomando doccia da incasso

_Complete concealed shower mixer



SX 686

Set da esterno per miscelatore monocomando doccia CS 535

_Shower mixer external parts for CS 535



SX 689

Set da esterno per miscelatore monocomando doccia/vasca CS 535 con deviatore 2 uscite

_Bath/shower mixer external parts for CS 535 with 2 outlet diverter



WJ 676

Miscelatore monocomando per wc/bidet esterno con flessibile LONG LIFE e doccia con chiusura

_WC/bidet mixer valve with integrated douche handset holder and LONG LIFE flexible hose

* interasse corpo - bocca

UNIX the range



CRISTINA

AISI 316 L

LAVABO - BIDET
_WASHBASIN - BIDET

VASCA - DOCCIA
_BATH - SHOWER



UX 220

Miscelatore monocomando REGULAR per lavabo con scarico Up&Down da 1"1/4

_Basin mixer REGULAR with 1"1/4 Up&Down waste



UX 223

Miscelatore monocomando LARGE per lavabo con scarico Up&Down da 1"1/4

_Basin mixer LARGE with 1"1/4 Up&Down waste



UX 227

Miscelatore monocomando MEDIUM per lavabo con scarico Up&Down da 1"1/4

_Basin mixer MEDIUM with 1"1/4 Up&Down waste

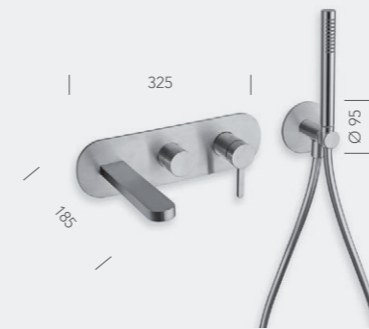

UX 102 | UX 103

Set da esterno per miscelatore monocomando doccia/vasca CS 100 (comando destro) - CS 101 (comando sinistro) con deviatore 2/3 uscite, doccetta anticalcare, flessibile LONG LIFE

_Bath/shower mixer external parts for CS 100 (right side) - CS 101 (left side) with 2/3 outlet diverter, LONG LIFE flexible hose, anti-lime hand shower



XX 142 | XX 143

Miscelatore termostatico per bordo vasca con deviatore 2/3 uscite

_Deck mounted thermostatic bath mixer with 2/3 outlets diverter



UX 602 | UX 603

Set da esterno per miscelatore monocomando doccia/vasca CS 100 (comando destro) - CS 101 (comando sinistro) con deviatore 2/3 uscite, doccetta anticalcare, flessibile LONG LIFE

_Bath/shower mixer external parts for CS 100 (right side) - CS 101 (left side) with 2/3 outlet diverter, anti-lime hand shower, LONG LIFE flexible hose



UX 222

Miscelatore monocomando TALL per lavabo con scarico Up&Down da 1"1/4

_Basin mixer TALL with 1"1/4 Up&Down waste



UX 256

Set da esterno miscelatore monocomando lavabo REGULAR per CS 200 (comando destro) - CS 201 (comando sinistro) con scarico Up&Down da 1"1/4

_Wall mounted basin mixer REGULAR external parts for CS 200 (right side) - CS 201 (left side) with 1"1/4 Up&Down waste



UX 320

Miscelatore monocomando per bidet con scarico Up&Down da 1"1/4

_Bidet mixer with 1"1/4 Up&Down waste



UX 686

Set da esterno per miscelatore monocomando doccia CS 535

_Shower mixer external parts for CS 535



UX 689

Set da esterno per miscelatore monocomando doccia/vasca CS 535 con deviatore 2 uscite

_Bath/shower mixer external parts for CS 535 with 2 outlet diverter

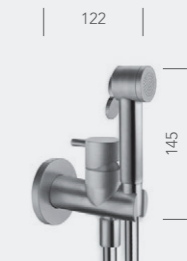

WJ 676

Miscelatore monocomando per wc/bidet esterno con flessibile LONG LIFE e doccetta con chiusura

_WC/bidet mixer valve with integrated douche handset holder and LONG LIFE flexible hose

* interasse corpo - bocca

OUTDOOR / INDOOR SHOWERS



CRISTINA

AISI 316 L

* 345

2100

WX 511

Colonna doccia da esterno/
interno a pavimento
con rubinetto d'arresto
monoacqua, sistema di
fissaggio e alimentazione
a terra, e sistema di
svuotamento acqua antigelo

Outdoor/indoor floor
mounted shower column
with one-water stopcock,
ground fixing and water
supply system, and
antifreeze emptying water
system

Ø 42



* 345

2100

WX 509

Colonna doccia da esterno/
interno a pavimento
con rubinetto d'arresto
monoacqua, sistema di
fissaggio e alimentazione
esterna

Outdoor/indoor floor
mounted shower column
with one-water stopcock,
ground fixing system and
external water supply

Ø 42



* 345

2110

WX 515

Colonna doccia da esterno/
interno a pavimento con
rubicetto temporizzato
monoacqua, getto lava
piedi temporizzato, sistema
di fissaggio e alimentazione
a terra, e sistema di
svuotamento acqua antigelo

Outdoor/indoor floor
mounted shower column
with one-water self-closing
tap, feet washer self-closing
jet, ground fixing and
water supply system, and
antifreeze emptying water
system

Ø 60



* 355

2130

WX 510

Colonna doccia da esterno/
interno a pavimento con
miscelazione progressiva,
sistema di fissaggio e
alimentazione a terra, e
sistema di svuotamento
acqua antigelo

Outdoor/indoor floor
mounted shower column
with progressive mixing
valve, ground fixing and
water supply system, and
antifreeze emptying water
system

Ø 100



* 355

2130

WX 520

Colonna doccia da esterno/
interno a pavimento
con miscelazione
monocomando, sistema di
fissaggio e alimentazione
a terra, e sistema di
svuotamento acqua antigelo

Outdoor/indoor floor
mounted shower column
with mixing valve, ground
fixing and water supply
system, and antifreeze
emptying water system

Ø 100



* 345

2100

WX 514

Colonna doccia da esterno/
interno a pavimento con
miscelazione progressiva,
sistema di fissaggio e
alimentazione a terra, e
sistema di svuotamento
acqua antigelo

Outdoor/indoor floor
mounted shower column
with progressive mixing
valve, ground fixing and
water supply system, and
antifreeze emptying water
system

Ø 60



* 345

2100

WX 524

Colonna doccia da esterno/
interno a pavimento
con miscelazione
monocomando, sistema di
fissaggio e alimentazione
a terra, e sistema di
svuotamento acqua antigelo

Outdoor/indoor floor
mounted shower column
with mixing valve, ground
fixing and water supply
system, and antifreeze
emptying water system

Ø 60



* 345

2115

WX 527

Colonna doccia da esterno/
interno a pavimento
con miscelazione
monocomando, sistema di
fissaggio e alimentazione
a terra, e sistema di
svuotamento acqua antigelo

Outdoor/indoor floor
mounted shower column
with mixing valve, ground
fixing and water supply
system, and antifreeze
emptying water system

Ø 76



* interasse corpo - bocca

CONTEMPORARY LINES

FORME ESSENZIALI E SUPERFICI PULITE CARATTERIZZANO TUTTE LE SERIE DELLA GAMMA CONTEMPORARY.

_SIMPLE SHAPES AND CLEAN SURFACES CHARACTERISE ALL THE LINES OF THE CONTEMPORARY RANGE.

BEAK	p. 60
BOLLICINE	p. 64
DELTA	p. 68
DIARIO	p. 72
EXCLUSIVE	p. 74
ITALY	p. 80
KING	p. 90
OMEGA	p. 94
PIC	p. 96
PROFILO	p.100
QUADRI	p.108
QUADRI S	p.112
QUEEN	p.116
RUBINETTO	p.120
TABULA	p.124
TRICOLORE VERDE	p.130
UNIC	p.136
WC JET	p.140
THE RANGE Technical Specifications	p.142

BEAK

design DANELON MERONI

Creata dalla designer Claudia Danelon dello studio DanelonMeroni Ltd, la serie BEAK riscopre un "minimalismo dolce" con forme semplici e superfici delicate. Una nuova combinazione di volumi e proporzioni reinterpreta con naturalezza l'archetipo del rubinetto. La bocca di erogazione diventa estensione graduale del corpo cilindrico verticale e si estende in forma armonica a ricordare l'eleganza del cigno. Da qui il nome della collezione "BEAK".

_Designed by Claudia Danelon from DanelonMeroni Ltd study, the series BEAK rediscovers a "soft minimalism" offering simple and delicate shapes. This new bathroom taps range transforms the volumes and proportions of the tap. The spout becomes a gradual extension of the vertical cylindrical body into a harmonious shape to remind the elegance of the swan. Hence the name "BEAK" for this collection.

BE 205

BE 205



BE 242



BE 102

BOLLICINE

Con un corpo cilindrico possente, che svetta fino alla leva di comando, il miscelatore dona alle sale da bagno contemporanee indiscussa classe e stile rigoroso.

Dalla sua particolare bocca, che si dilata assumendo una forma trapezoidale, esce una morbida cascata d'acqua.

_With a powerful cylindrical body, towering up to the control lever, the mixer gives undisputed class and rigorous style to the contemporary bathroom.

From its particular mouth, which expands into a trapezoidal shape, comes a soft waterfall.



BO 290



BO 126



DELTA

È la serie ideale per un ambiente contemporaneo ed essenziale. Il rubinetto è realizzato con il corpo e la bocca fusi in un pezzo unico a esaltare un'estrema pulizia funzionale ed estetica.

_It's the ideal range designed for a contemporary and essential bathroom. The tap is made with the body and the spout casted into a single piece to enhance style and function.



DE 222



DE 228

DIARIO

—
design MAKIO HASUIKE & CO

Rigore estetico e formale sono i punti di forza della serie DIARIO, che trae ispirazione da uno stile urbano e minimalista.

Le linee rette e gli angoli in evidenza donano a questi rubinetti un look preciso e raffinato, perfetto per il bagno di un loft industriale. Corpo e bocca fusi in un unico pezzo esaltano l'essenzialità del design.

_Inspired by an urban and minimalist style, the DIARIO series key points are the aesthetic and formal accuracy.

The prominent straight lines and angles gives these taps a refined and minimal look, the perfect choice for a loft's bathroom. Body and mouth cast in a single piece enhance the essential design.



DI 264

EXCLUSIVE

Forme antiche rivisitate in chiave moderna: il rubinetto di un tempo re-inventato pensando agli stili di vita di oggi e domani.

Una serie prestigiosa e funzionale dotata di maniglie piacevoli da guardare, ma anche pratiche nell'utilizzo.

_A series characterized by antique shapes produced in a modern way; it seems the old-fashioned sanitary fittings thought and studied again considering contemporary and future life style.

A prestigious and functional series provided with pleasant and functional handles.



EV 242



EV 108 13



XV 752 + PD 626 + PD 411 + PD 014



ITALY

—
 BUSETTI - GARUTI - REDAELLI INDUSTRIAL DESIGNERS

Ispirata alle sontuose sale da bagno degli anni Venti e Trenta, ITALY è progettata in collaborazione con i designers Busetti Garuti Redaelli. Permette di abbinare a diverse finiture galvaniche per il corpo, numerose essenze di marmo o pietra per le manopole. L'utilizzo di questi materiali impreziosisce e rende unico ogni prodotto grazie alla naturale variabilità del singolo pezzo. Il risultato è un rubinetto dal grande impatto visivo capace di stimolare al contempo il tatto e la vista.

It is inspired by the sumptuous baths of the Twenties and Thirties, ITALY is designed in collaboration with the designers Busetti Garuti Redaelli. Exclusive design that allows you to combine different galvanic finishes for the body to numerous marble or stone essences for handles. The use of these materials enhances and makes each product unique thanks to the natural variability of every single piece. The result is a faucet with an intense expressive power, able to stimulate at the same time touch and sight.





IT 205 51 VG



IT 242 46 CC

ITALY

design BUSETTI - GARUTI - REDAELLI INDUSTRIAL DESIGNERS

IT 217 75 MQ



CONTEMPORARY LINES CRISTINA

IT 619 75





IT 189 51 CC

MARMI E PIETRE

MARBLES AND STONES

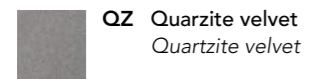

QZ Quartzite velvet
Quartzite velvet



CC Calacatta lucido
Polished Calacatta



CR Crema nuova velvet
Crema nuova velvet



MQ Marquinia lucido
Polished Marquinia



GF Grafite lucida
Polished Graphite



VG Guatemala lucido
Polished Guatemala



FINITURE METALLICHE

METALLIC FINISHINGS



51 Cromo
Chrome



72 Cromo nero lucido
polished black chrome



80 Metallic lucido
Polished metallic



52 Oro giallo
Yellow gold



77 Metallic spazzolato
Brushed metallic



46 Oro rosa lucido
Polished rose gold



75 Cromo nero spazzolato
Brushed black chrome



34 Oro rosa spazzolato
Brushed rose gold

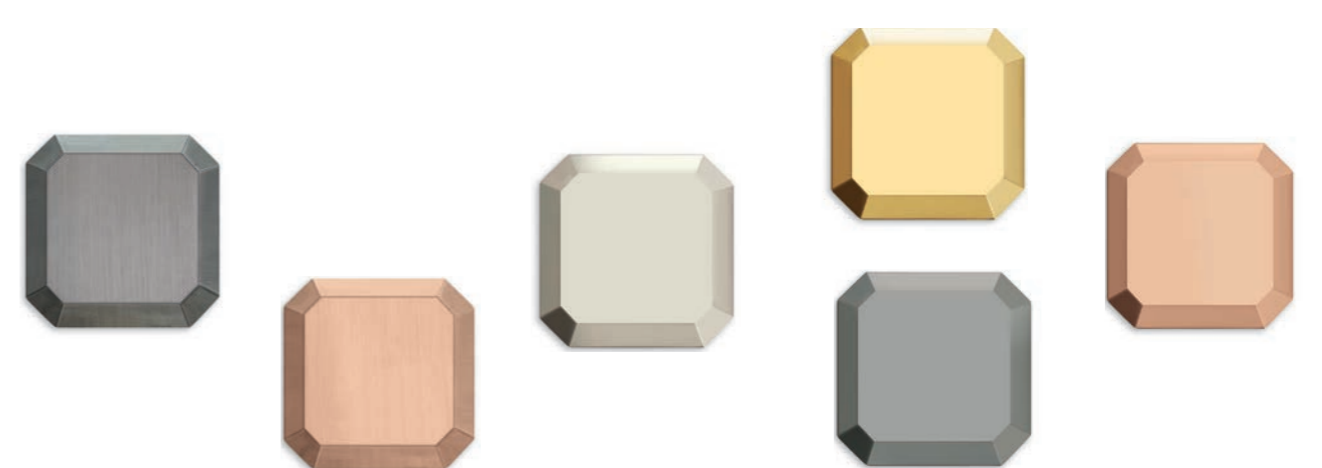

KING

—
design MC2 ARCHITETTI ASSOCIATI

Squadrato e mascolino, si slancia mostrando le spigolature, forte e fiero, come un Re. Se il vero lusso è poter godere del proprio tempo e prendersi cura di sé stessi, allora tanto meglio farlo con stile e regale maestria.

_Square and masculine, it reaches up showing its edges, strong and proud, just like a King. If real luxury is being able to enjoy our time and take care of ourselves, there is nothing better than doing it with style and regal mastery.

KG 227



KG 212



KG 256

OMEGA

Rigore estetico e formale sono i punti di forza della serie OMEGA, che trae ispirazione da uno stile urbano e minimalista. Le linee rette e gli angoli in evidenza donano a questi rubinetti un look essenziale e raffinato, perfetto per il bagno di un loft industriale.

_Inspired by an urban and minimalist style, the OMEGA series key points are the aesthetic and formal accuracy. The prominent straight lines and angles gives these taps a refined and essential look, the perfect choice for a loft's bathroom.



PIC

Diverse forme cilindriche si fondono armoniosamente per dare vita a PIC, una linea raffinata dall'eleganza senza tempo. Le superfici riflettono lo spazio circostante, creando un affascinante gioco di specchi.

_Several cylindrical shapes blend together harmoniously to create PIC, a series oozing refined timeless elegance. The shiny surfaces reflect the surroundings, creating fascinating mirror effects.



PM 237



PM 228



PROFILO

design GIAMPIERO CASTAGNOLI

Disegnata da Giampiero Castagnoli, PROFILO è la nuova serie di CRISTINA caratterizzata da un design ispirato a forme geometriche ed essenziali.

_PROFILO, designed by Giampiero Castagnoli, is CRISTINA's new series, featuring a modern design inspired by essential geometric shapes.



PF 220 13



PF 227





PF 258

PF 102

QUADRI

QUADRI esprime un design pulito, plasmato nel segno della razionalità e della purezza stilistica in grado di suscitare grandi emozioni, grazie alla lucentezza delle sue superfici piane e dei tagli geometrici.

_QUADRI is the expression of a clean design, shaped by rationality and stylistic purity that can bring about strong emotions, thanks to the brilliance of its flat surfaces and geometric lines.



QM 227 13

QM 102



QM 189

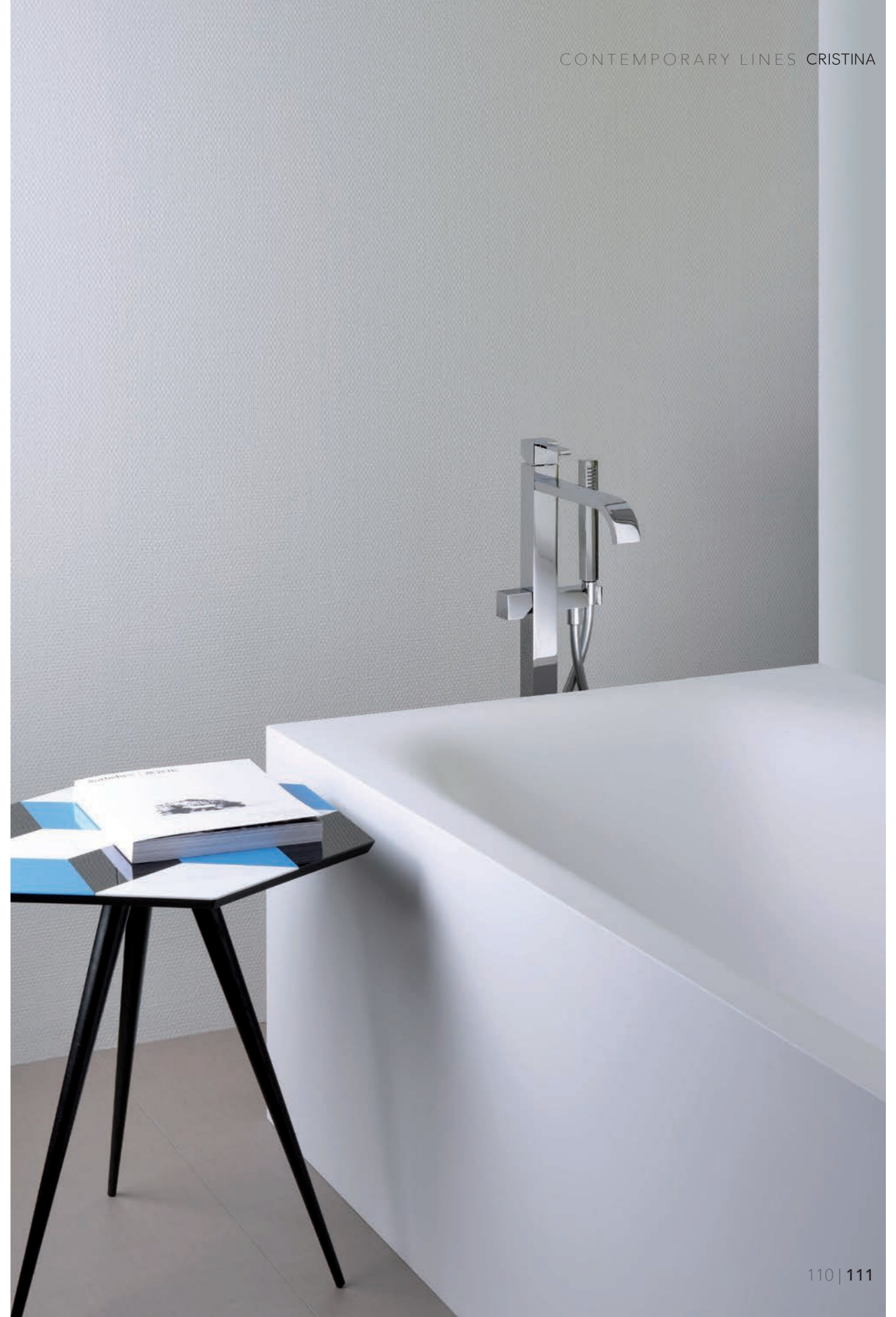

QUADRI S

La forma geometrica ispiratrice perde la sua rigidità e acquista una morbidezza unica: è questa l'essenza della serie QUADRI S, la cui linea si distingue per la presenza di un quadrato dagli angoli dolcemente arrotondati. Lo stesso elemento, osservato in pianta, richiama il nostro logo.

The inspirational geometric shape loses its rigidity and acquires a unique softness: this is the essence of the QUADRI S range, highlighted by a square element with gently rounded corners. The same square concept recalls our logo.

CONTEMPORARY LINES CRISTINA

Q S 220 77





QS 222



QS 256

QUEEN

design MC2 ARCHITETTI ASSOCIATI

Tondo, femminile, morbido e delicato nelle forme, ma dallo spirito determinato e volitivo come una Regina. Che cosa rende particolare una regina, il portamento e l'eleganza? Certamente, ma soprattutto la consapevolezza che ogni gesto, anche il più piccolo deve avere il tocco dell'unicità.

_The shape is round, feminine, soft and delicate, but the spirit is determined and strong-willed just like a Queen. What makes a Queen special, the gait and elegance? Sure, but also the awareness that every gesture, even the smallest must have a touch of uniqueness.



QE 212



QE 102

RUBINETTO

design MAKIO HASUIKE & CO

Semplice e puro, RUBINETTO lascia un segno preciso e riconoscibile, senza essere invadente. Il risultato è una linea decisamente innovativa, rigorosa e morbida allo stesso tempo, enfatizzata dalla grande attenzione per le proporzioni e i dettagli e destinata a diventare un'icona di stile.

_Simple and neat, RUBINETTO leaves a precise and recognizable mark, without being intrusive. The result is a highly innovative range, rigorous and soft at the same time, emphasized by the great attention to proportions and details; a series that will become a style icon.





RU 224



RU 102

TABULA

angeletti ruzza design

Il suo corpo squadrato, delineato da un profilo netto e forte, è il risultato di un sapiente esercizio stilistico di sottrazione in cui ogni elemento superfluo è stato eliminato per concentrarsi sulla pura essenza delle forme. La grande leva per la fuoriuscita dell'acqua, dalle dimensioni importanti ma dal profilo sottile, nasce proprio da uno studio di allineamenti e proporzioni, combinando estetica e funzionalità alla perfezione: come un vero e proprio gioiello, TABULA arricchisce l'atmosfera circostante con la sua eleganza preziosa e senza tempo.

_An angular body, defined by a clean, decisive profile, is the result of a skilled stylistic exercise in subtraction, where every unnecessary element has been stripped away to concentrate on the pure essence of form. The large, lever-like handle, with robust dimensions balanced by a thin profile, is the result of a study on detail and proportion, perfectly combining aesthetics and practicality. Like a precious jewel, TABULA enriches the space around it thanks to its brilliant, timeless elegance.



TA 102

TA 220



TA 256



TA 102

TRICOLORE VERDE

Linee geometriche semplici, in grado di esprimere una sofisticata eleganza high-tech, sono quelle che caratterizzano la serie TRICOLORE VERDE.

E' disponibile in diverse altezze ed è stata arricchita di nuove tecnologie, una gamma ricca e versatile, che rendere questa serie un nuovo classico.

_TRICOLORE VERDE is characterised by simple geometric lines, expressing sophisticated high-tech elegance. Available in different heights and enhanced with new technologies Tricolore Verde is a rich and versatile range, that makes this serie a modern classic.



TV 220 13



TV 220 24





TV 189



TV 189

UNIC

Così come lo Yin e lo Yang, la serie UNIC è stata concepita per miscelare spiriti antitetici e complementari: estetica e funzionalità, spigoli e curve, accuratezza e semplicità. Un'armonia geometrica, un connubio formale che esprime purezza, leggerezza e precisione.

Just like Yin and Yang, the UNIC series is designed to mix antithetical and complementary souls: aesthetics and functionality, edges and curves, accuracy and simplicity. A geometric harmony, a formal combination expressing purity, lightness and precision.

CONTEMPORARY LINES CRISTINA



UC 220

UC 256



UC 222



WC JET



WJ 676

BEAK the range

LAVABO - BIDET
_WASHBASIN - BIDET



BE 220

Miscelatore monocomando REGULAR per lavabo con scarico Up&Down da 1"1/4

_Basin mixer REGULAR with 1"1/4 Up&Down waste



BE 222

Miscelatore monocomando TALL per lavabo con scarico Up&Down da 1"1/4

_Basin mixer TALL with 1"1/4 Up&Down waste



BE 205

Miscelatore bicomando REGULAR per lavabo 3 fori con scarico Up&Down da 1"1/4

_3 hole basin mixer REGULAR with 1"1/4 Up&Down waste

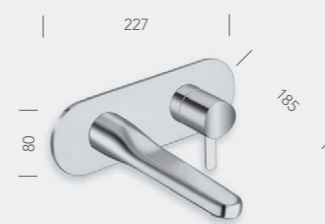

BE 256

Set da esterno miscelatore monocomando lavabo REGULAR per CS 200 (comando destro) - CS 201 (comando sinistro) con scarico Up&Down da 1"1/4 e piastra in metallo

_Wall mounted basin mixer REGULAR external parts for CS 200 (right side) - CS 201 (left side) with 1"1/4 Up&Down waste and metal plate



BE 258

Set da esterno miscelatore monocomando lavabo LARGE per CS 200 (comando destro) - CS 201 (comando sinistro) con scarico Up&Down da 1"1/4 e piastra in metallo

_Wall mounted basin mixer LARGE external parts for CS 200 (right side) - CS 201 (left side) with 1"1/4 Up&Down waste and metal plate

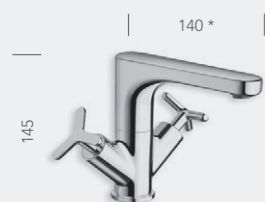

BE 226

Miscelatore bicomando REGULAR per lavabo con scarico Up&Down da 1"1/4

_Basin mixer REGULAR with 1"1/4 Up&Down waste



BE 242

Set da esterno miscelatore bicomando lavabo REGULAR per CS 233 (comandi laterali) - CS 234 (comando destro) con scarico Up&Down da 1"1/4

_Wall mounted basin mixer REGULAR external parts for CS 233 (side controls) - CS 234 (right side) with 1"1/4 Up&Down waste



BE 243

Set da esterno miscelatore bicomando lavabo LARGE per CS 233 (comandi laterali) - CS 234 (comando destro) con scarico Up&Down da 1"1/4

_Wall mounted basin mixer LARGE external parts for CS 233 (side controls) - CS 234 (right side) with 1"1/4 Up&Down waste



BE 320

Miscelatore monocomando per bidet con scarico Up&Down da 1"1/4

_Bidet mixer with 1"1/4 Up&Down waste

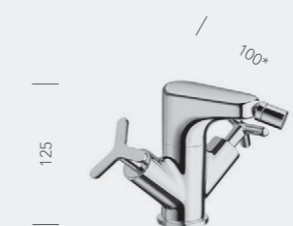

BE 326

Miscelatore bicomando per bidet con scarico Up&Down da 1"1/4

_Bidet mixer with 1"1/4 Up&Down waste

* interasse corpo - bocca

BEAK the range

CRISTINA

VASCA - DOCCIA
_BATH - SHOWER

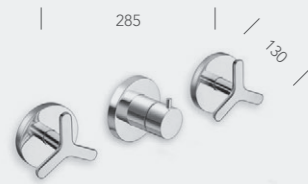

BE 114

Set completo per miscelatore bicomando doccia/ vasca da incasso con deviatore 2 uscite

_Complete 3 hole concealed bath/shower mixer with 2 outlets diverter

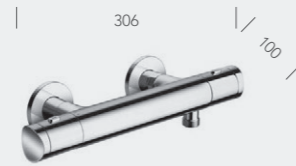

BE 451

Miscelatore termostatico per doccia esterno

_External thermostatic shower mixer



BE 102 | BE 103

Set da esterno per miscelatore monocomando doccia/vasca CS 100 (comando destro) - CS 101 (comando sinistro) con deviatore 2/3 uscite, doccetta anticalcare in ottone, flessibile LONG LIFE e piastra in metallo

_Bath/shower mixer external parts for CS 100 (right side) - CS 101 (left side) with 2/3 outlet diverter, LONG LIFE flexible hose, brass anti-lime hand shower and metal plate



BE 686

Set da esterno per miscelatore monocomando doccia CS 535 con piastra in metallo

_Shower mixer external parts for CS 535 with metal plate



BE 689

Set da esterno per miscelatore monocomando doccia/vasca CS 535 con deviatore 2 uscite e piastra in metallo

_Bath/shower mixer external parts for CS 535 with 2 outlet diverter and metal plate

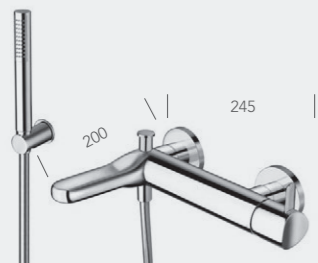

BE 180

Miscelatore monocomando per vasca esterno con flessibile LONG LIFE e doccetta anticalcare

_External bath mixer with LONG LIFE flexible hose and anti-lime hand shower

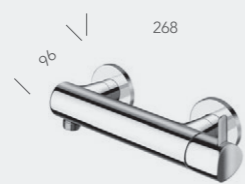

BE 481

Miscelatore monocomando per doccia esterno

_External shower mixer



BE 458

Miscelatore termostatico "corpo freddo" per doccia esterno con maniglie in ABS, colonna girevole, soffione SANDWICH SPECIAL ø 30 cm, doccetta anticalcare con supporto scorrevole e flessibile LONG LIFE

_ "Cold touch" external thermostatic shower mixer with ABS handle, turning column pipe, ø 30 cm SANDWICH SPECIAL overhead shower, anti-lime hand shower with slide rail and LONG LIFE flexible hose

* interasse corpo - bocca

BOLLICINE the range

CRISTINA

LAVABO - BIDET
_WASHBASIN - BIDET



BO 244

Miscelatore monocomando SMALL per lavabo con scarico Up&Down da 1"1/4 - Erogazione libera

_Basin mixer SMALL with 1"1/4 Up&Down waste - Free flow



BO 220

Miscelatore monocomando REGULAR per lavabo con scarico Up&Down da 1"1/4 - Erogazione libera

_Basin mixer REGULAR with 1"1/4 Up&Down waste - Free flow



BO 227

Miscelatore monocomando MEDIUM per lavabo con scarico Up&Down da 1"1/4 - Erogazione libera - Erogazione libera

_Basin mixer MEDIUM with 1"1/4 Up&Down waste - Free flow

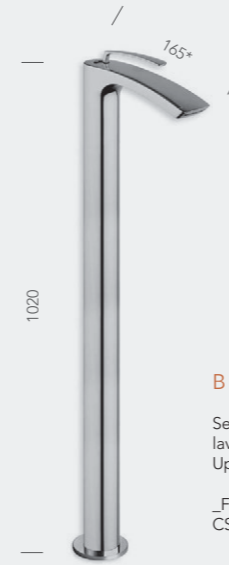

BO 290

Set da esterno per miscelatore monocomando lavabo a pavimento CS 290 con scarico Up&Down da 1"1/4 - Erogazione libera

_Floor mounted basin mixer external parts for CS 290 with 1"1/4 Up&Down waste - Free flow



BO 242

Set da esterno miscelatore bicomando lavabo REGULAR per CS 233 con scarico Up&Down da 1"1/4 e piastra in metallo - Erogazione libera

_Wall mounted basin mixer REGULAR external parts for CS 233 with 1"1/4 Up&Down waste and metal plate - Free flow



BO 228

Miscelatore monocomando TALL per lavabo con scarico Up&Down da 1"1/4 - Erogazione libera

_Basin mixer TALL with 1"1/4 Up&Down waste - Free flow



BO 205

Miscelatore bicomando REGULAR per lavabo 3 fori con scarico Up&Down da 1"1/4 - Erogazione libera

_3 hole basin mixer REGULAR with 1"1/4 Up&Down waste - Free flow



BO 256

Set da esterno miscelatore monocomando lavabo REGULAR per CS 200 (comando destro) - CS 201 (comando sinistro) con scarico Up&Down da 1"1/4 e piastra in metallo - Erogazione libera

_Wall mounted basin mixer REGULAR external parts for CS 200 (right side) - CS 201 (left side) with 1"1/4 Up&Down waste and metal plate - Free flow



BO 320

Miscelatore monocomando per bidet con scarico Up&Down da 1"1/4 - Erogazione libera

_Bidet mixer with 1"1/4 Up&Down waste - Free flow



BO 330

Miscelatore bicomando per bidet 3 fori con scarico Up&Down da 1"1/4 - Erogazione libera

_3 hole bidet mixer with 1"1/4 Up&Down waste - Free flow

* interasse corpo - bocca

BOLLICINE the range

VASCA - DOCCIA
_BATH - SHOWER



BO 102 | BO 103

Set da esterno per miscelatore monocomando doccia/vasca CS 100 (comando destro) - CS 101 (comando sinistro) con deviatore 2/3 uscite, doccetta anticalcare, flessibile LONG LIFE e piastra in metallo - Erogazione libera

_Bath/shower mixer external parts for CS 100 (right side) - CS 101 (left side) with 2/3 outlet diverter, LONG LIFE flexible hose, anti-lime hand shower and metal plate - Free flow



BO 111

Set completo per miscelatore bicomando vasca da incasso con bocca erogazione, flessibile LONG LIFE e doccetta anticalcare orientabile - Erogazione libera

_Complete 3 hole concealed bath mixer with spout, LONG LIFE flexible hose and adjustable anti-lime hand shower



BO 113

Set completo per miscelatore bicomando vasca da incasso con bocca erogazione, soffione anticalcare ispezionabile, flessibile LONG LIFE e doccetta anticalcare - Erogazione libera

_Complete 3 hole concealed bath mixer with spout, checkable anti-lime overhead shower, LONG LIFE flexible hose and anti-lime hand shower - Free flow



BO 121

Miscelatore monocomando per bordo vasca 2 fori con deviatore, doccetta anticalcare estraibile e FOLLOW ME - Erogazione libera

_2 hole deck mounted bath mixer with diverter, pull-out anti-lime hand shower and FOLLOW ME - Free flow



BO 126

Miscelatore bicomando per bordo vasca 4 fori con deviatore, bocca erogazione, doccetta anticalcare estraibile e FOLLOW ME - Erogazione libera

_4 hole deck mounted bath mixer with diverter, spout, pull-out anti-lime hand shower and FOLLOW ME - Free flow



BO 114

Set completo per miscelatore bicomando doccia/vasca da incasso con deviatore 2 uscite - Erogazione libera

Complete 3 hole concealed bath/shower mixer with 2 outlets diverter - Free flow

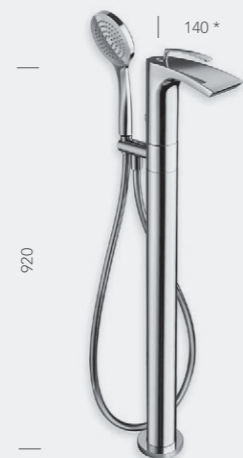

BO 190

Set da esterno per miscelatore monocomando vasca a pavimento CS 290 con flessibile LONG LIFE e doccetta anticalcare - Erogazione libera

_Floor mounted bath mixer external parts for CS 290 with LONG LIFE flexible hose and anti-lime hand shower - Free flow



BO 686

Set da esterno per miscelatore monocomando doccia CS 535 con piastra in metallo

_ Shower mixer external parts for CS 535 with metal plate



BO 689

Set da esterno per miscelatore monocomando doccia/vasca CS 535 con deviatore 2 uscite e piastra in metallo

_ Bath/shower mixer external parts for CS 535 with 2 outlet diverter and metal plate

DELTA the range

CRISTINA

LAVABO - BIDET
_WASHBASIN - BIDET



DE 220

Miscelatore monocomando REGULAR per lavabo con scarico Up&Down da 1"1/4

_Basin mixer REGULAR with 1"1/4 Up&Down waste



DE 227

Miscelatore monocomando MEDIUM per lavabo con scarico Up&Down da 1"1/4

_Basin mixer MEDIUM with 1"1/4 Up&Down waste



DE 222

Miscelatore monocomando TALL per lavabo con scarico Up&Down da 1"1/4

_Basin mixer TALL with 1"1/4 Up&Down waste



DE 320

Miscelatore monocomando per bidet con scarico Up&Down da 1"1/4

_Bidet mixer with 1"1/4 Up&Down waste



DE 228

Miscelatore monocomando REGULAR per lavabo con bocca girevole e scarico Up&Down da 1"1/4

_Basin mixer REGULAR with swivel spout and 1"1/4 Up&Down waste

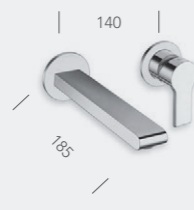

DE 237

Set completo per miscelatore monocomando lavabo REGULAR da incasso con scarico Up&Down da 1"1/4

_Complete wall mounted basin mixer REGULAR with 1"1/4 Up&Down waste



DE 238

Set completo per miscelatore monocomando lavabo LARGE da incasso con scarico Up&Down da 1"1/4

_Complete wall mounted basin mixer LARGE with 1"1/4 Up&Down waste

* interasse corpo - bocca

DELTA the range

CRISTINA

VASCA - DOCCIA
_BATH - SHOWER



DE 180

Miscelatore monocomando per vasca esterno con flessibile LONG LIFE e doccetta 3 funzioni anticalcare

_External bath mixer with LONG LIFE flexible hose and anti-lime 3 functions hand shower

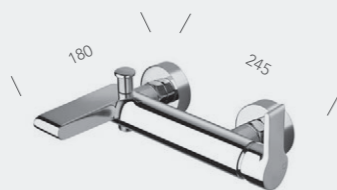

DE 187

Miscelatore monocomando per vasca esterno

_External bath mixer



DE 121

Miscelatore monocomando per bordo vasca 4 fori con deviatore bocca erogazione, doccetta 3 funzioni anticalcare estraibile, FOLLOW ME e piastra in metallo

_4 hole deck mounted bath mixer with diverter, spout, pull-out antilime 3 functions hand shower, FOLLOW ME and metal plate



DE 686

Set da esterno per miscelatore monocomando doccia CS 535 con piastra in metallo

_Shower mixer external parts for CS 535 with metal plate



DE 656

Set da esterno per miscelatore monocomando doccia CS 535 con piastra in ABS

_Shower mixer external parts for CS 535 with ABS cover plate



DE 659

Set da esterno per miscelatore monocomando doccia/vasca CS 535 con deviatore 2 uscite e piastra in ABS

_ Bath/shower mixer external parts with 2 outlets diverter for CS 535 and ABS cover plate



DE 481

Miscelatore monocomando per doccia esterno

_External shower mixer

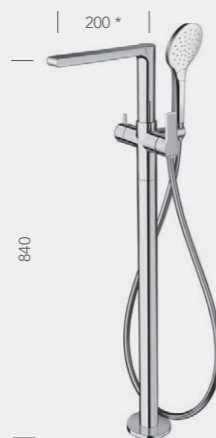

DE 189

Set da esterno per miscelatore monocomando vasca a pavimento CS 290 con flessibile LONG LIFE e doccetta 3 funzioni anticalcare con miscelazione indipendente

_Floor mounted bath mixer external parts for CS 290 with LONG LIFE flexible hose and anti-lime 3 functions hand shower with independent mixing



DE 649

Set completo per miscelatore monocomando doccia/vasca da incasso con deviatore 2 uscite e piastra in ABS

_ Complete concealed bath/shower mixer with 2 outlets diverter and ABS cover plate



DE 118

Set completo per miscelatore monocomando doccia da incasso con piastra in metallo

_ Complete concealed shower mixer with metal plate

* interasse corpo - bocca

DIARIO the range

CRISTINA

LAVABO - BIDET
_WASHBASIN - BIDET



DI 220

Miscelatore monocomando REGULAR per lavabo con scarico Up&Down da 1"1/4

_Basin mixer REGULAR with 1"1/4 Up&Down waste



DI 263

Miscelatore monocomando MEDIUM per lavabo con scarico Up&Down da 1"1/4

_Basin mixer MEDIUM with 1"1/4 waste



DI 222

Miscelatore monocomando TALL per lavabo con scarico Up&Down da 1"1/4

_Basin mixer TALL with 1"1/4 Up&Down waste



DI 320

Miscelatore monocomando per bidet con scarico Up&Down da 1"1/4

_Bidet mixer with 1"1/4 Up&Down waste

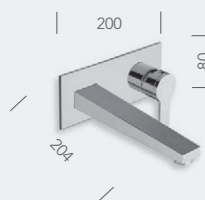

DI 256

Set da esterno miscelatore monocomando lavabo REGULAR per CS 200 (comando destro) - CS 201 (comando sinistro) con scarico Up&Down da 1"1/4 e piastra in metallo

_Wall mounted basin mixer REGULAR external parts for CS 200 (right side) - CS 201 (left side) with 1"1/4 Up&Down waste and metal plate

* interasse corpo - bocca

DIARIO the range

VASCA - DOCCIA
_BATH - SHOWER

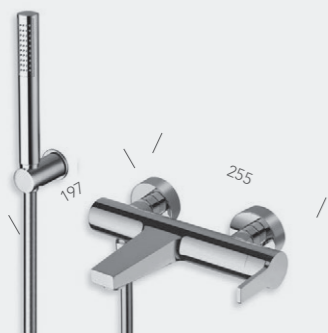

DI 100

Miscelatore monocomando per vasca esterno con flessibile LONG LIFE e doccetta anticalcare

_External bath mixer with LONG LIFE flexible hose and anti-lime hand shower

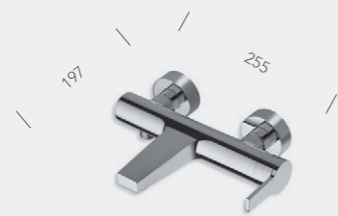

DI 107

Miscelatore monocomando per vasca esterno

_External bath mixer

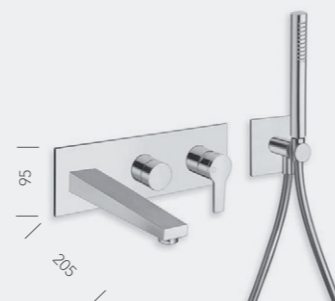

DI 102 | DI 103

Set da esterno per miscelatore monocomando doccia/vasca CS 100 (comando destro) - CS 101 (comando sinistro) deviatore 2/3 uscite, doccetta anticalcare, flessibile LONG LIFE e piastra in metallo

_Bath/shower mixer external parts for CS 100 (right side) - CS 101 (left side) with 2/3 outlet diverter, anti-lime hand shower, LONG LIFE flexible hose and metal plate

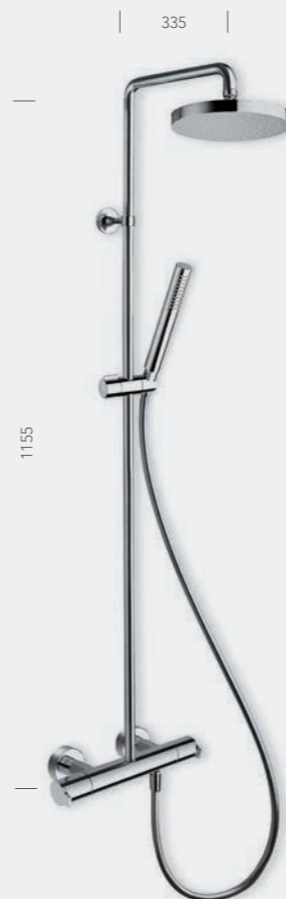

DI 486

Miscelatore termostatico per doccia esterno con colonna girevole, soffione anticalcare ispezionabile, doccetta anticalcare con supporto scorrevole e flessibile LONG LIFE

_ External thermostatic shower mixer with turning column pipe, checkable anti-lime overhead shower, anti-lime hand shower with slide rail and LONG LIFE flexible hose



DI 686

Set da esterno per miscelatore monocomando doccia CS 535 con piastra in metallo

_Shower mixer external parts for CS 535 with metal plate



DI 689

Set da esterno per miscelatore monocomando doccia/vasca CS 535 con deviatore 2 uscite e piastra in metallo

_Bath/shower mixer external parts for CS 535 with 2 outlet diverter and metal plate

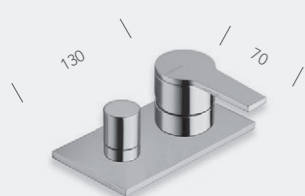

DI 129

Miscelatore monocomando per bordo vasca con deviatore 2 uscite e piastra in metallo

_Deck mounted bath mixer with 2 outlet diverter and metal plate

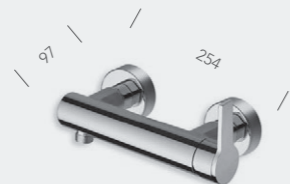

DI 401

Miscelatore monocomando per doccia esterno

_External shower mixer

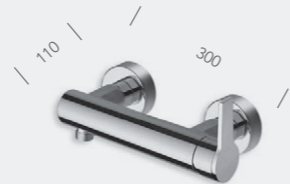

DI 451

Miscelatore termostatico per doccia esterno

_External thermostatic shower mixer

EXCLUSIVE the range

LAVABO - BIDET
_WASHBASIN - BIDET



EV 220

Miscelatore monocomando progressivo REGULAR per lavabo con scarico Up&Down da 1"1/4

_Progressive basin mixer REGULAR with 1"1/4 Up&Down waste



EV 225

Miscelatore monocomando progressivo MEDIUM per lavabo con scarico Up&Down da 1"1/4

_Progressive basin mixer MEDIUM with 1"1/4 Up&Down waste



EV 222

Miscelatore monocomando progressivo TALL per lavabo con scarico Up&Down da 1"1/4

_Progressive basin mixer TALL with 1"1/4 Up&Down waste



EV 230

Rubinetto "acqua fredda" da 1/2"

_1/2" "cold water" tap



EV 242

Set da esterno miscelatore bicomando lavabo REGULAR per CS 233 - CS 234 con scarico Up&Down da 1"1/4

_Wall mounted basin mixer REGULAR external parts for CS 233 - CS 234 with 1"1/4 Up&Down waste



EV 241

Set da esterno miscelatore bicomando lavabo LARGE per CS 233 - CS 234 con scarico Up&Down da 1"1/4

_Wall mounted basin mixer LARGE external parts for CS 233 - CS 234 with 1"1/4 Up&Down waste



EV 205

Miscelatore bicomando REGULAR per lavabo 3 fori con scaricoda 1"1/4 e asta comando

_3 hole basin mixer REGULAR with 1"1/4 pop up waste



EV 226

Miscelatore bicomando REGULAR per lavabo con scarico da 1"1/4 e asta comando

_Basin mixer REGULAR with 1"1/4 pop up waste



EV 248

Miscelatore bicomando TALL per lavabo con scarico Up&Down da 1"1/4

_Basin mixer TALL with 1"1/4 Up&Down waste



EV 320

Miscelatore monocomando progressivo per bidet con scarico Up&Down da 1"1/4

_Progressive bidet mixer with 1"1/4 Up&Down waste



EV 326

Miscelatore bicomando per bidet con scarico da 1"1/4 e asta comando

_Bidet mixer with 1"1/4 pop up waste



EV 330

Miscelatore bicomando per bidet 3 fori con scarico da 1"1/4 e asta comando

_3 hole bidet mixer with 1"1/4 pop up waste

* interasse corpo - bocca

EXCLUSIVE the range

VASCA - DOCCIA
_BATH - SHOWER



EV 180

Miscelatore bicomando per vasca esterno con flessibile LONG LIFE e doccetta anticalcare

_External bath mixer with LONG LIFE flexible hose and anti-lime hand shower

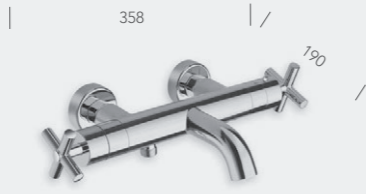

EV 157

Miscelatore termostatico per vasca esterno

_External thermostatic bath mixer



EV 157

Miscelatore termostatico per vasca esterno

_External thermostatic bath mixer



XV 142 | XV 143

Miscelatore termostatico per bordo vasca con deviatore 2/3 uscite

_Deck mounted thermostatic bath mixer with 2/3 outlets diverter



EV 122

Miscelatore bicomando per bordo vasca 4 fori con doccetta anticalcare estraibile, deviatore 2 uscite e FOLLOW ME

_4 hole deck mounted bath mixer with pull-out anti-lime hand shower, 2 outlets diverter and FOLLOW ME



EV 124

Miscelatore bicomando LARGE per bordo vasca 4 fori con bocca erogazione, doccetta anticalcare estraibile e deviatore

_4 hole deck mounted bath mixer LARGE with diverter, spout and pull-out anti-lime hand shower

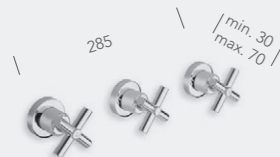

EV 114

Set completo per miscelatore bicomando doccia/vasca da incasso con deviatore 2 uscite

_Complete 3 hole concealed bath/shower mixer with 2 outlets diverter



EV 113

Set completo per miscelatore bicomando vasca da incasso con bocca erogazione, soffione anticalcare ispezionabile, flessibile LONG LIFE e doccetta anticalcare

_Complete 3 hole concealed bath mixer with spout, checkable anti-lime overhead shower, LONG LIFE flexible hose and anti-lime hand shower

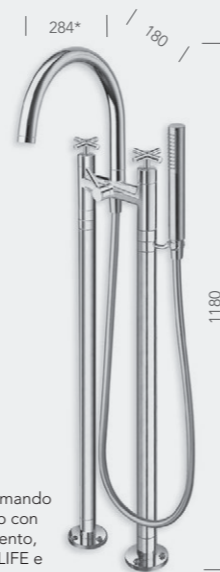

EV 108

Miscelatore bicomando per vasca esterno con colonne a pavimento, flessibile LONG LIFE e doccetta anticalcare

_Floor mounted bath mixer with LONG LIFE flexible hose and anti-lime hand shower



EV 126

Miscelatore bicomando REGULAR per bordo vasca 4 fori con bocca erogazione, doccetta anticalcare estraibile e deviatore

_4 hole deck mounted bath mixer REGULAR with diverter, spout and pull-out anti-lime hand shower



EV 131

Miscelatore bicomando per bordo vasca con deviatore 2 uscite e piastra in metallo

_Deck mounted bath mixer with 2 outlet diverter and metal plate



EV 481

Miscelatore bicomando per doccia esterno

_External shower mixer

* interasse corpo - bocca

EXCLUSIVE the range

VASCA - DOCCIA
_BATH - SHOWER

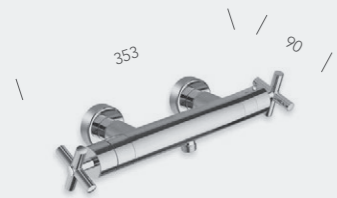

EV 451

Miscelatore termostatico per doccia esterno
_External thermostatic shower mixer

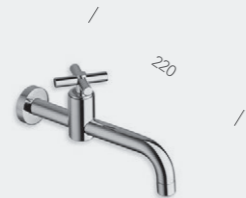

EV 652

Rubinetto "acqua fredda" a muro da 1/2"
_1/2" wall mounted "cold water" tap



EV 666

Set da esterno per miscelatore monocomando progressivo doccia CS 535 con piastra in ABS
_Progressive shower mixer external parts for CS 535 with ABS plate

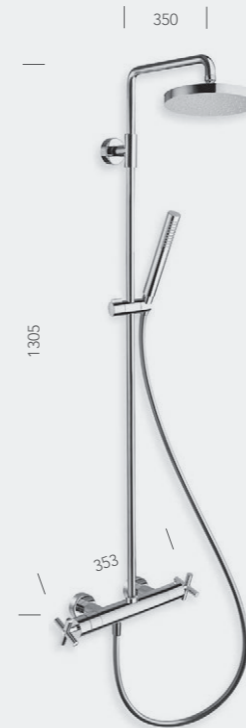

EV 456

Miscelatore termostatico per doccia esterno con colonna girevole, soffione anticalcare ispezionabile, doccetta anticalcare con supporto scorrevole e flessibile LONG LIFE
_External thermostatic shower mixer with turning column pipe, checkable anti-lime overhead shower, anti-lime hand shower with slide rail and LONG LIFE flexible hose



EV 161

Set completo per miscelatore bicomando doccia da incasso con saliscendi, flessibile LONG LIFE, doccetta anticalcare orientata e soffione anticalcare ispezionabile
_Complete 3 hole concealed shower mixer with sliding bar, LONG LIFE flexible hose, skewed anti-lime hand shower and anti-lime checkable overhead shower



EV 114

Set completo per miscelatore bicomando doccia/vasca da incasso con deviatore 2 uscite
_Complete 3 hole concealed bath/shower mixer with 2 outlets diverter

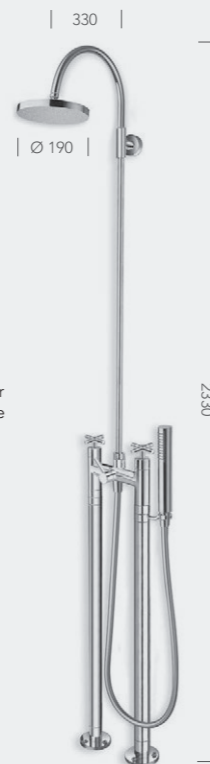

EV 409

Miscelatore bicomando per doccia esterno con colonne a pavimento, soffione anticalcare ispezionabile, flessibile LONG LIFE e doccetta anticalcare
_Floor mounted shower mixer with checkable anti-lime overhead shower, LONG LIFE flexible hose and anti-lime hand shower



EV 669

Set da esterno per miscelatore monocomando progressivo doccia/vasca CS 535 con deviatore 2 uscite e piastra in ABS
_Progressive bath/shower mixer external parts for CS 535 with 2 outlet diverter and ABS plate

ITALY the range

LAVABO - BIDET
_WASHBASIN - BIDET



IT 210

Miscelatore monocomando progressivo per lavabo REGULAR con scarico Up&Down da 1"1/4

_Progressive basin mixer REGULAR with 1"1/4 Up&Down waste



IT 220

Miscelatore monocomando REGULAR per lavabo con scarico Up&Down da 1"1/4

_Basin mixer REGULAR with 1"1/4 Up&Down waste



IT 217

Miscelatore monocomando progressivo per lavabo MEDIUM con scarico Up&Down da 1"1/4

_Progressive basin mixer MEDIUM with 1"1/4 Up&Down waste

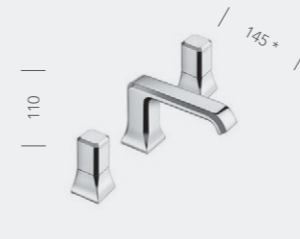

IT 205

Miscelatore bicomando REGULAR per lavabo 3 fori con scarico Up&Down da 1"1/4

_3 hole basin mixer REGULAR with 1"1/4 Up&Down waste

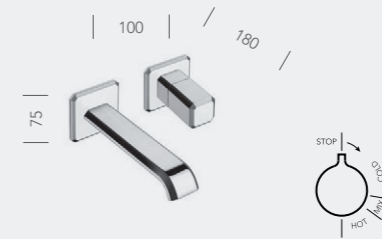

IT 247

Set da esterno miscelatore monocomando progressivo lavabo REGULAR per CS 200 (comando destro) - CS 201 (comando sinistro) con scarico Up&Down da 1"1/4

_Progressive wall mounted basin mixer REGULAR external parts for CS 200 (right side) - CS 201 (left side) with 1"1/4 Up&Down waste

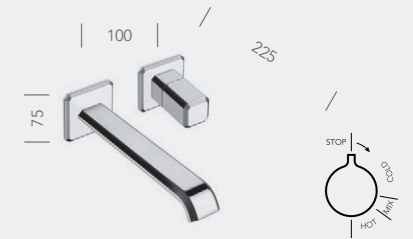

IT 249

Set da esterno miscelatore monocomando progressivo lavabo LARGE per CS 200 (comando destro) - CS 201 (comando sinistro) con scarico Up&Down da 1"1/4

_Progressive wall mounted basin mixer LARGE external parts for CS 200 (right side) - CS 201 (left side) with 1"1/4 Up&Down waste



IT 227

Miscelatore monocomando MEDIUM per lavabo con scarico Up&Down da 1"1/4

_Basin mixer MEDIUM with 1"1/4 Up&Down waste



IT 280

Set da esterno per miscelatore monocomando progressivo lavabo a pavimento CS 290 con scarico Up&Down da 1"1/4

_Floor mounted progressive basin mixer external parts for CS 290 with 1"1/4 Up&Down waste



IT 290

Set da esterno per miscelatore monocomando lavabo a pavimento CS 290 con scarico Up&Down da 1"1/4

_Floor mounted basin mixer external parts for CS 290 with 1"1/4 Up&Down waste

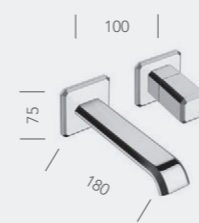

IT 257

Set da esterno miscelatore monocomando lavabo REGULAR per CS 200 (comando destro) - CS 201 (comando sinistro) con scarico Up&Down da 1"1/4

_Wall mounted basin mixer REGULAR external parts for CS 200 (right side) - CS 201 (left side) with 1"1/4 Up&Down waste

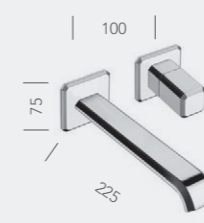

IT 259

Set da esterno miscelatore monocomando lavabo LARGE per CS 200 (comando destro) - CS 201 (comando sinistro) con scarico Up&Down da 1"1/4

_Wall mounted basin mixer LARGE external parts for CS 200 (right side) - CS 201 (left side) with 1"1/4 Up&Down waste

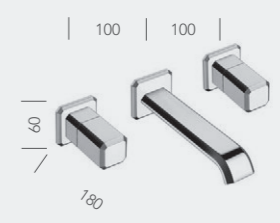

IT 242

Set da esterno miscelatore bicomando lavabo REGULAR per CS 233 (comandi laterali) - CS 234 (comando destro) con scarico Up&Down da 1"1/4

_Wall mounted basin mixer REGULAR external parts for CS 233 (side controls) - CS 234 (right side) with 1"1/4 Up&Down waste

* interasse corpo - bocca

ITALY the range

CRISTINA

LAVABO - BIDET
_WASHBASIN - BIDET

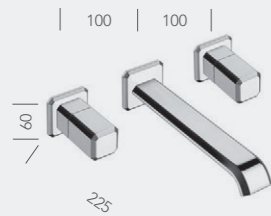

IT 243

Set da esterno miscelatore bicomando lavabo LARGE per CS 233 (comandi laterali) - CS 234 (comando destro) con scarico Up&Down da 1"1/4

_Wall mounted basin mixer LARGE external parts for CS 233 (side controls) - CS 234 (right side) with 1"1/4 Up&Down waste



IT 310

Miscelatore monocomando progressivo per bidet con scarico Up&Down da 1"1/4

_Progressive bidet mixer with 1"1/4 Up&Down waste



IT 320

Miscelatore monocomando per bidet con scarico Up&Down da 1"1/4

_Bidet mixer with 1"1/4 Up&Down waste

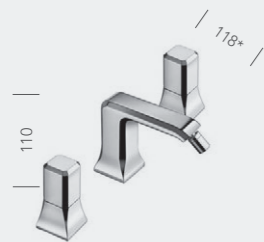

IT 307

Miscelatore bicomando per bidet 3 fori con scarico Up&Down da 1"1/4

_3 hole bidet mixer with 1"1/4 Up&Down waste

* interasse corpo - bocca

VASCA - DOCCIA
_BATH - SHOWER

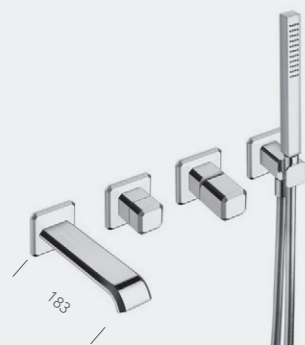

IT 102 | IT 103

Set da esterno per miscelatore monocomando doccia/vasca CS 100 (comando destro) - CS 101 (comando sinistro) con deviatore 2/3 uscite, doccetta anticalcare in ottone, flessibile LONG LIFE e piastra in metallo

_Bath/shower mixer external parts for CS 100 (right side) - CS 101 (left side) with 2/3 outlet diverter, LONG LIFE flexible hose, brass anti-lime hand shower and metal plate

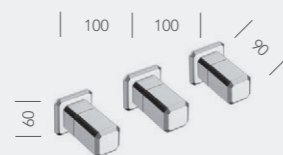

IT 162

Set da esterno per miscelatore bicomando doccia/vasca CS 115 con deviatore 2 uscite

_3 hole bath/shower mixer external parts for CS 115 with 2 outlet diverter



IT 165

Set da esterno per miscelatore bicomando vasca CS 115 con deviatore 2 uscite, bocca erogazione, doccetta anticalcare in metallo e flessibile LONG LIFE

_3 hole bath mixer external parts for CS 115 with 2 outlet diverter, spout, metal anti-lime hand shower and LONG LIFE flexible hose

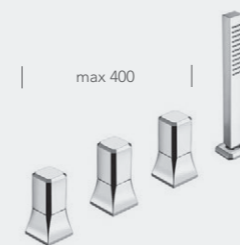

IT 122

Miscelatore bicomando per bordo vasca 4 fori con doccetta anticalcare estraibile, deviatore 2 uscite e FOLLOW ME

_4 hole deck mounted bath mixer with pull-out anti-lime hand shower, 2 outlet diverter and FOLLOW ME

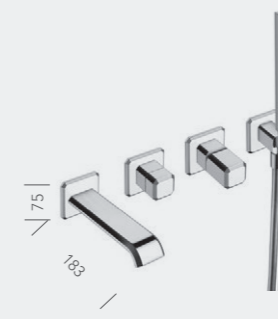

IT 602

Set da esterno per miscelatore monocomando doccia/vasca CS 100 (comando destro) - CS 101 (comando sinistro) con deviatore 2 uscite, doccetta anticalcare in ottone, flessibile LONG LIFE

_Bath/shower mixer external parts for CS 100 (right side) - CS 101 (left side) with 2 outlet diverter, brass anti-lime hand shower, LONG LIFE flexible hose

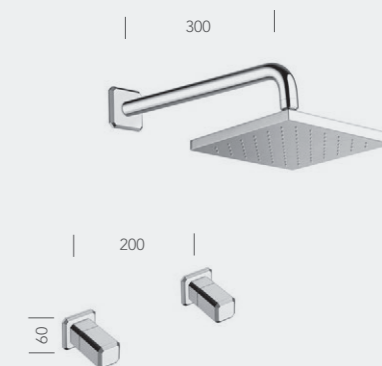

IT 617

Set da esterno per miscelatore bicomando doccia CS 233 con soffione anticalcare ispezionabile

_Shower mixer external parts for CS 233 with checkable anti-lime overhead shower

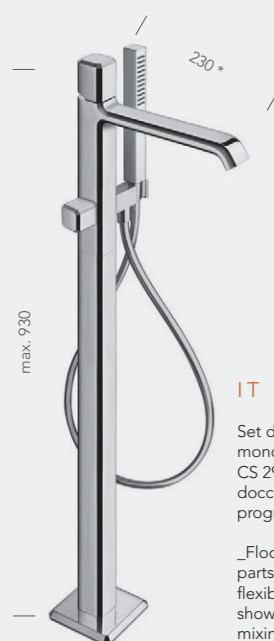

IT 189

Set da esterno per miscelatore monocomando vasca a pavimento CS 290 con flessibile LONG LIFE e doccetta anticalcare con miscelazione progressiva indipendente

_Floor mounted bath mixer external parts for CS 290 with LONG LIFE flexible hose and anti-lime hand shower with independent progressive mixing

* interasse corpo - bocca

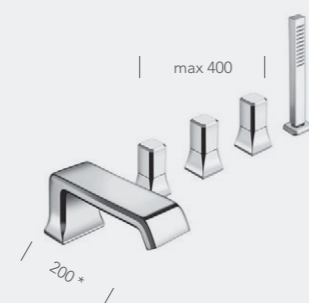

IT 121

Miscelatore bicomando per bordo vasca 5 fori con deviatore, bocca erogazione, doccetta anticalcare estraibile in metallo e FOLLOW ME

_5 hole deck mounted bath mixer with diverter, spout, pull-out metal anti-lime hand shower and FOLLOW ME

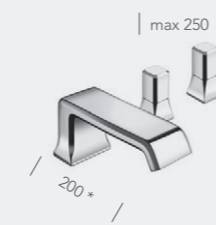

IT 120

Miscelatore bicomando per bordo vasca 3 fori con bocca erogazione (1 uscita)

_3 hole deck mounted bath mixer with spout (1 outlet)

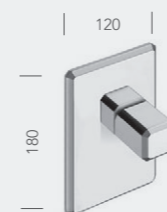

IT 686

Set da esterno per miscelatore monocomando doccia CS 535 con piastra in metallo

_Shower mixer external parts for CS 535 with metal plate

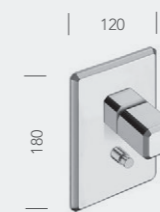

IT 689

Set da esterno per miscelatore monocomando doccia/vasca CS 535 con deviatore 2 uscite e piastra in metallo

_Bath/shower mixer external parts for CS 535 with 2 outlet diverter and metal plate



IT 620

Rubinetto d'arresto da 1/2"

_1/2" stopcock

KING the range

CRISTINA

LAVABO - BIDET
_WASHBASIN - BIDET



KG 220

Miscelatore monocomando REGULAR per lavabo con scarico Up&Down da 1"1/4

_Basin mixer REGULAR with 1"1/4 Up&Down waste



KG 210

Miscelatore monocomando REGULAR per lavabo con scarico Up&Down da 1"1/4

_Basin mixer REGULAR with 1"1/4 Up&Down waste



KG 227

Miscelatore monocomando MEDIUM per lavabo con scarico Up&Down da 1"1/4

_Basin mixer MEDIUM with 1"1/4 Up&Down waste

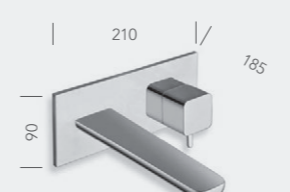

KG 256

Set da esterno miscelatore monocomando lavabo REGULAR per CS 200 (comando destro) - CS 201 (comando sinistro) con scarico Up&Down da 1"1/4 e piastra in metallo

_Wall mounted basin mixer REGULAR external parts for CS 200 (right side) - CS 201 (left side) with 1"1/4 Up&Down waste and metal plate

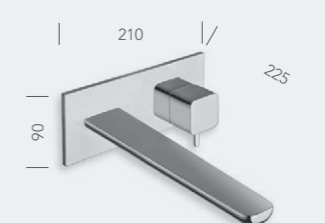

KG 258

Set da esterno miscelatore monocomando lavabo LARGE per CS 200 (comando destro) - CS 201 (comando sinistro) con scarico Up&Down da 1"1/4 e piastra in metallo

_Wall mounted basin mixer LARGE external parts for CS 200 (right side) - CS 201 (left side) with 1"1/4 Up&Down waste and metal plate



KG 320

Miscelatore monocomando per bidet con scarico Up&Down da 1"1/4

_Bidet mixer with 1"1/4 Up&Down waste



KG 217

Miscelatore monocomando MEDIUM per lavabo con scarico Up&Down da 1"1/4

_Basin mixer MEDIUM with 1"1/4 Up&Down waste



KG 222

Miscelatore monocomando TALL per lavabo con scarico Up&Down da 1"1/4

_Basin mixer TALL with 1"1/4 Up&Down waste



KG 212

Miscelatore monocomando TALL per lavabo con scarico Up&Down da 1"1/4

_Basin mixer TALL with 1"1/4 Up&Down waste



KG 310

Miscelatore monocomando per bidet con scarico Up&Down da 1"1/4

_Bidet mixer with 1"1/4 Up&Down waste

* interasse corpo - bocca

KING the range

CRISTINA

VASCA - DOCCIA
_BATH - SHOWER

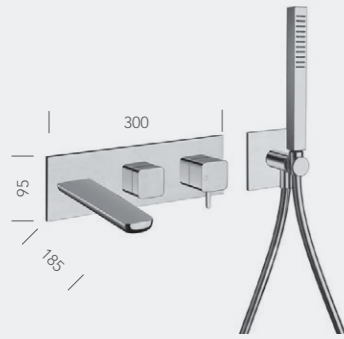

KG 102

Set da esterno per miscelatore monocomando doccia/vasca CS 100 (comando destro) - CS 101 (comando sinistro) con deviatore 2 uscite, doccetta anticalcare in ottone, flessibile LONG LIFE e piastra in metallo

_Bath/shower mixer external parts for CS 100 (right side) - CS 101 (left side) with 2 outlet diverter, LONG LIFE flexible hose, brass anti-lime hand shower and metal plate

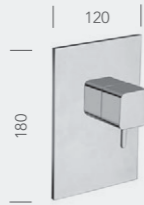

KG 686

Set da esterno per miscelatore monocomando doccia CS 535 con piastra in metallo

_Shower mixer external parts for CS 535 with metal plate



KG 689

Set da esterno per miscelatore monocomando doccia/vasca CS 535 con deviatore 2 uscite e piastra in metallo

_Bath/shower mixer external parts for CS 535 with 2 outlet diverter and metal plate

OMEGA the range

CRISTINA

LAVABO - BIDET
_WASHBASIN - BIDET



OG 220

Miscelatore monocomando REGULAR per lavabo con scarico Up&Down da 1"1/4

_Basin mixer REGULAR with 1"1/4 Up&Down waste



OG 227

Miscelatore monocomando MEDIUM per lavabo con scarico Up&Down da 1"1/4

_Basin mixer MEDIUM with 1"1/4 waste



OG 222

Miscelatore monocomando TALL per lavabo con scarico Up&Down da 1"1/4

_Basin mixer TALL with 1"1/4 Up&Down waste



OG 320

Miscelatore monocomando per bidet con scarico Up&Down da 1"1/4

_Bidet mixer with 1"1/4 Up&Down waste



OG 228

Miscelatore monocomando REGULAR per lavabo con bocca girevole e scarico Up&Down da 1"1/4

_Basin mixer REGULAR with swivel spout and 1"1/4 Up&Down waste

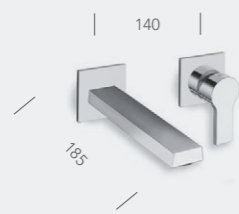

OG 237

Set completo per miscelatore monocomando lavabo REGULAR da incasso con scarico Up&Down da 1"1/4

_Complete wall mounted basin mixer REGULAR with 1"1/4 Up&Down waste

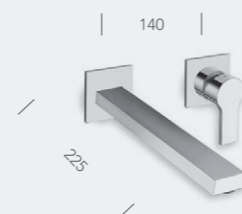

OG 238

Set completo per miscelatore monocomando lavabo LARGE da incasso con scarico Up&Down da 1"1/4

_Complete wall mounted basin mixer LARGE with 1"1/4 Up&Down waste

* interasse corpo - bocca

OMEGA the range

VASCA - DOCCIA
_BATH - SHOWER



OG 180

Miscelatore monocomando per vasca esterno con flessibile LONG LIFE e doccetta 3 funzioni anticalcare

_External bath mixer with LONG LIFE flexible hose and anti-lime 3 functions hand shower

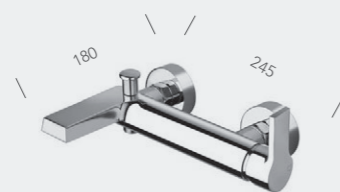

OG 187

Miscelatore monocomando per vasca esterno

_External bath mixer

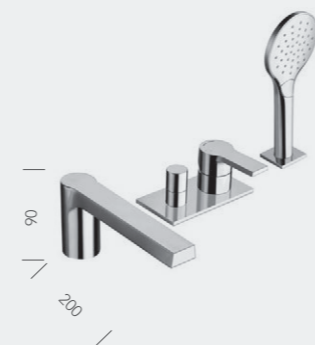

OG 121

Miscelatore monocomando per bordo vasca 4 fori con deviatore bocca erogazione, doccetta anticalcare estraibile, FOLLOW ME e piastra in metallo

_4 hole deck mounted bath mixer with diverter, spout, pull-out anti-lime hand shower, FOLLOW ME and metal plate



OG 686

Set da esterno per miscelatore monocomando doccia CS 535 con piastra in metallo

_Shower mixer external parts for CS 535 with metal plate



OG 659

Set da esterno per miscelatore monocomando doccia/vasca CS 535 con deviatore 2 uscite e piastra in ABS

_ Bath/shower mixer external parts for CS 535 with 2 outlet diverter and ABS cover plate

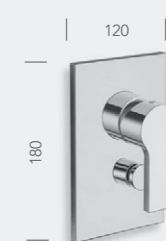

OG 649

Set da esterno per miscelatore monocomando doccia/vasca CS 535 con deviatore 2 uscite e piastra in ABS

_ Bath/shower mixer external parts for CS 535 with 2 outlet diverter and ABS cover plate

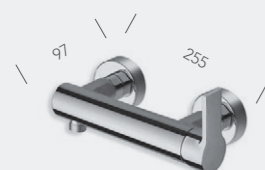

OG 481

Miscelatore monocomando per doccia esterno

_External shower mixer

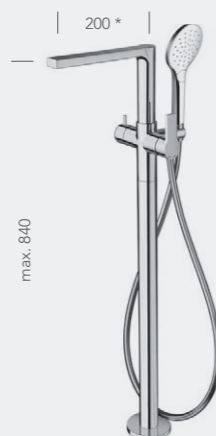

OG 189

Set da esterno per miscelatore monocomando vasca a pavimento CS 290 con flessibile LONG LIFE e doccetta 3 funzioni anticalcare con miscelatore indipendente

_Floor mounted bath mixer external parts for CS 290 with LONG LIFE flexible hose and anti-lime 3 functions hand shower with independent mixing



OG 118

Set da esterno per miscelatore monocomando doccia da incasso con piastra in metallo

_ Complete concealed shower mixer with metal plate

* interasse corpo - bocca

PIC the range

CRISTINA

LAVABO - BIDET
_WASHBASIN - BIDET



PM 220

Miscelatore monocomando REGULAR per lavabo con scarico Up&Down da 1"1/4

_Basin mixer REGULAR with 1"1/4 Up&Down waste



PM 222

Miscelatore monocomando TALL per lavabo con scarico Up&Down da 1"1/4

_Basin mixer TALL with 1"1/4 Up&Down waste



PM 226

Miscelatore monocomando REGULAR per lavabo con scarico Up&Down da 1"1/4

_Basin mixer REGULAR with 1"1/4 Up&Down waste



PM 320

Miscelatore monocomando per bidet con scarico Up&Down da 1"1/4

_Bidet mixer with 1"1/4 Up&Down waste



PM 326

Miscelatore monocomando per bidet con scarico Up&Down da 1"1/4

_Bidet mixer with 1"1/4 Up&Down waste



PM 228

Miscelatore monocomando TALL per lavabo con scarico Up&Down da 1"1/4

_Basin mixer TALL with 1"1/4 Up&Down waste



PM 237

Set completo per miscelatore monocomando lavabo REGULAR da incasso con scarico Up&Down da 1"1/4

_Complete wall mounted basin mixer REGULAR with 1"1/4 Up&Down waste

* interasse corpo - bocca

PIC the range

CRISTINA

VASCA - DOCCIA
_BATH - SHOWER



PM 108 | 110

Set completo per miscelatore monocomando doccia/vasca da incasso con deviatore 2 | 3 uscite, doccetta anticalcare, flessibile LONG LIFE e piastra in metallo

_Complete concealed bath/shower mixer with 2 | 3 outlet diverter, anti-lime hand shower, LONG LIFE flexible hose and metal plate



PM 656

Set da esterno per miscelatore monocomando doccia/vasca CS 535 con piastra in ABS

_ Shower mixer external parts for CS 535 with ABS cover plate



PM 659

Set da esterno per miscelatore monocomando doccia/vasca CS 535 con deviatore 2 uscite e piastra in ABS

_ Bath/shower mixer external parts with 2 outlets for CS 535 and ABS cover plate



PM 118

Set completo per miscelatore monocomando doccia/vasca da incasso con piastra in metallo

_ Complete concealed shower mixer with metal plate



PM 649

Set completo per miscelatore monocomando doccia/vasca da incasso con deviatore 2 uscite e piastra in ABS

_ Complete concealed bath/shower mixer with 2 outlets diverter and ABS cover plate

PROFILO the range

CRISTINA

LAVABO - BIDET
_WASHBASIN - BIDET



PF 220

Miscelatore monocomando REGULAR per lavabo con scarico Up&Down da 1"1/4

_Basin mixer REGULAR with 1"1/4 Up&Down waste



PF 227

Miscelatore monocomando MEDIUM per lavabo con scarico Up&Down da 1"1/4

_Basin mixer MEDIUM with 1"1/4 Up&Down waste



PF 222

Miscelatore monocomando TALL per lavabo con scarico Up&Down da 1"1/4

_Basin mixer TALL with 1"1/4 Up&Down waste



PF 258

Set da esterno miscelatore monocomando lavabo LARGE per CS 200 (comando destro) con scarico Up&Down da 1"1/4 e piastra in metallo

_Wall mounted basin mixer LARGE external parts for CS 200 (right side) with 1"1/4 Up&Down waste and metal plate

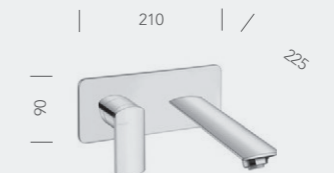

PF 248

Set da esterno miscelatore monocomando lavabo LARGE per CS 201 (comando sinistro) con scarico Up&Down da 1"1/4 e piastra in metallo

_Wall mounted basin mixer LARGE external parts for CS 200 (right side) with 1"1/4 Up&Down waste and metal plate

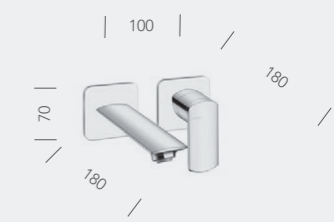

PF 257

Set da esterno miscelatore monocomando lavabo REGULAR per CS 200 (comando destro) con scarico Up&Down da 1"1/4 e piastra in metallo

_Wall mounted basin mixer REGULAR external parts for CS 200 (right side) with 1"1/4 Up&Down waste and metal plate



PF 290

Set da esterno per miscelatore monocomando lavabo a pavimento CS 290 con scarico Up&Down da 1"1/4

_Floor mounted basin mixer external parts for CS 290 with 1"1/4 Up&Down waste

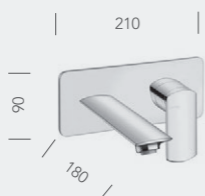

PF 256

Set da esterno miscelatore monocomando lavabo REGULAR per CS 200 (comando destro) con scarico Up&Down da 1"1/4 e piastra in metallo

_Wall mounted basin mixer REGULAR external parts for CS 200 (right side) with 1"1/4 Up&Down waste and metal plate



PF 246

Set da esterno miscelatore monocomando lavabo REGULAR per CS 201 (comando sinistro) con scarico Up&Down da 1"1/4 e piastra in metallo

_Wall mounted basin mixer REGULAR external parts for CS 200 (right side) with 1"1/4 Up&Down waste and metal plate

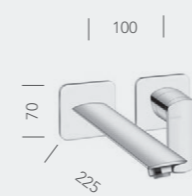

PF 259

Set da esterno miscelatore monocomando lavabo LARGE per CS 200 (comando destro) con scarico Up&Down da 1"1/4 e piastra in metallo

_Wall mounted basin mixer LARGE external parts for CS 200 (right side) with 1"1/4 Up&Down waste and metal plate



PF 320

Miscelatore monocomando per bidet con scarico Up&Down da 1"1/4

_Bidet mixer with 1"1/4 Up&Down waste

* interasse corpo - bocca

PROFILO the range

CRISTINA

VASCA - DOCCIA
_BATH - SHOWER



PF 181

Miscelatore monocomando per bordo vasca 4 fori con deviatore, bocca erogazione, doccetta anticalcare estraibile, FOLLOW ME e piastra in metallo- Erogazione libera

_4 hole deck mounted bath mixer with diverter, spout, pull-out anti-lime hand shower, FOLLOW ME and metal plate - Free flow

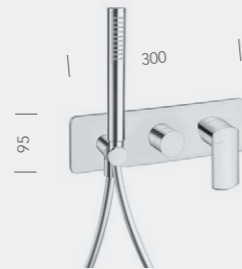

PF 602 | 603

Set completo per miscelatore monocomando doccia/vasca da incasso con deviatore 2 | 3 uscite, doccetta anticalcare, flessibile LONG LIFE e piastra in metallo

_Complete concealed bath/shower mixer with 2 | 3 outlet diverter, anti-lime hand shower, LONG LIFE flexible hose and metal plate

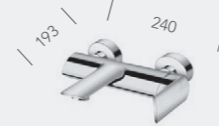

PF 107

Miscelatore monocomando per vasca esterno

_External bath mixer



PF 486

Miscelatore monocomando TALL per lavabo con scarico Up&Down da 1"1/4

_Basin mixer TALL with 1"1/4 Up&Down waste



PF 401

Miscelatore monocomando per doccia esterno

_External shower mixer



PF 686

Set da esterno per miscelatore monocomando doccia CS 535 con piastra in metallo

_Shower mixer external parts for CS 535 with metal plate

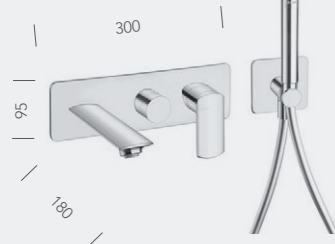

PF 102 | 103

Set completo per miscelatore monocomando doccia/vasca CS100 (comando destro) con deviatore 2/ 3 uscite, doccetta anticalcare, flessibile LONG LIFE e piastra in metallo

_Complete concealed bath/shower mixer CS100 (right side) with 2/3 outlet diverter, anti-lime hand shower, LONG LIFE flexible hose and metal plate



PF 189

Set da esterno per miscelatore monocomando vasca a pavimento CS 290 con flessibile LONG LIFE e doccetta anticalcare con miscelazione indipendente

_Floor mounted bath mixer external parts for CS 290 with LONG LIFE flexible hose and anti-lime hand shower with independent mixing

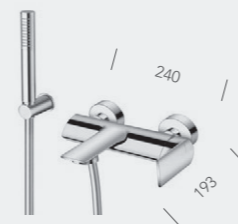

PF 100

Miscelatore monocomando per vasca esterno con flessibile LONG LIFE e doccetta anticalcare

_External bath mixer with LONG LIFE flexible hose and anti-lime hand shower



PF 409

Miscelatore monocomando MEDIUM per lavabo con scarico Up&Down da 1"1/4

_Basin mixer MEDIUM with 1"1/4 Up&Down waste



PF 689

Set da esterno per miscelatore monocomando doccia/vasca CS 535 con deviatore 2 uscite e piastra in metallo

_ Bath/shower mixer external parts for CS 535 with 2 outlet diverter and metal plate



PF 638

Set completo per miscelatore monocomando doccia da incasso con piastra in metallo

_ Complete concealed shower mixer with metal plate

* interasse corpo - bocca

QUADRI the range

CRISTINA

LAVABO - BIDET
_WASHBASIN - BIDET

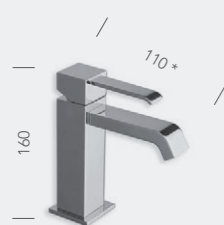

QM 220

Miscelatore monocomando REGULAR per lavabo con scarico Up&Down da 1"1/4

_Basin mixer REGULAR with 1"1/4 Up&Down waste

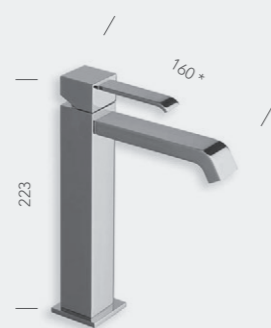

QM 227

Miscelatore monocomando MEDIUM per lavabo con scarico Up&Down da 1"1/4

_Basin mixer MEDIUM with 1"1/4 Up&Down waste

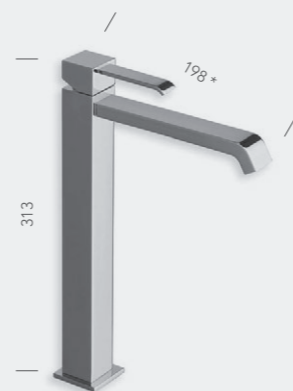

QM 228

Miscelatore monocomando TALL per lavabo con scarico Up&Down da 1"1/4

_Basin mixer TALL with 1"1/4 Up&Down waste



QD 205

Miscelatore bicomando REGULAR per lavabo 3 fori con scarico da 1"1/4 e asta comando

_3 hole basin mixer REGULAR with 1"1/4 pop up waste

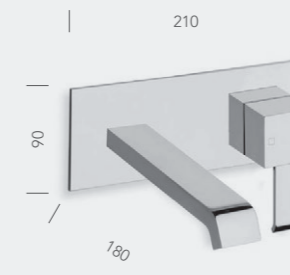

QM 256

Set da esterno miscelatore monocomando lavabo REGULAR per CS 200 (comando destro) - CS 201 (comando sinistro) con scarico Up&Down da 1"1/4 e piastra in metallo

_Wall mounted basin mixer REGULAR external parts for CS 200 (right side) - CS 201 (left side) with 1"1/4 Up&Down waste and metal plate

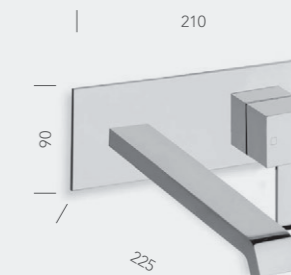

QM 258

Set da esterno miscelatore monocomando lavabo LARGE per CS 200 (comando destro) - CS 201 (comando sinistro) con scarico Up&Down da 1"1/4 e piastra in metallo

_Wall mounted basin mixer LARGE external parts for CS 200 (right side) - CS 201 (left side) with 1"1/4 Up&Down waste and metal plate

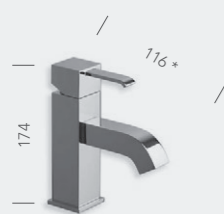

QM 223

Miscelatore monocomando LARGE per lavabo con scarico Up&Down da 1"1/4

_Basin mixer LARGE with 1"1/4 Up&Down waste

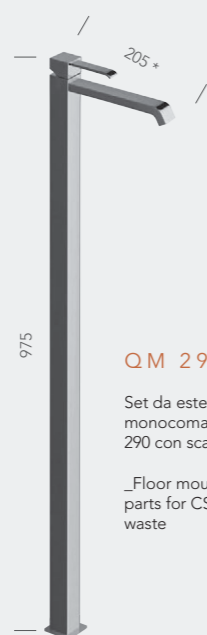

QM 290

Set da esterno per miscelatore monocomando lavabo a pavimento CS 290 con scarico Up&Down da 1"1/4

_Floor mounted basin mixer external parts for CS 290 with 1"1/4 Up&Down waste



QD 220

Miscelatore bicomando REGULAR per lavabo con scarico Up&Down da 1"1/4

_Basin mixer REGULAR with 1"1/4 Up&Down waste

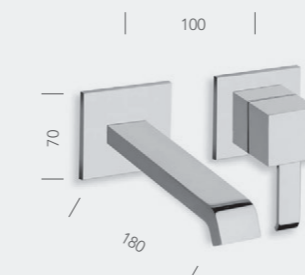

QM 257

Set da esterno miscelatore monocomando lavabo REGULAR per CS 200 (comando destro) - CS 201 (comando sinistro) con scarico Up&Down da 1"1/4

_Wall mounted basin mixer REGULAR external parts for CS 200 (right side) - CS 201 (left side) with 1"1/4 Up&Down waste

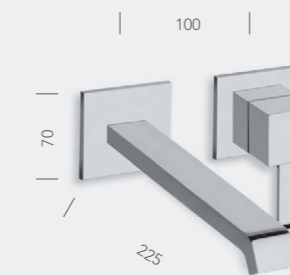

QM 259

Set da esterno miscelatore monocomando lavabo LARGE per CS 200 (comando destro) - CS 201 (comando sinistro) con scarico Up&Down da 1"1/4

_Wall mounted basin mixer LARGE external parts for CS 200 (right side) - CS 201 (left side) with 1"1/4 Up&Down waste

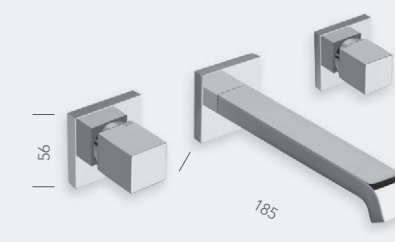

QD 242

Set da esterno miscelatore bicomando lavabo REGULAR per CS 233 (comandi laterali) - CS 234 (comando destro) con scarico Up&Down da 1"1/4

_Wall mounted basin mixer REGULAR external parts for CS 233 (side controls) - CS 234 (right side) with 1"1/4 Up&Down waste

* interasse corpo - bocca

QUADRI the range

CRISTINA

LAVABO - BIDET
_WASHBASIN - BIDET



QM 320

Miscelatore monocomando per bidet con scarico Up&Down da 1"1/4

_Bidet mixer with 1"1/4 Up&Down waste



QD 320

Miscelatore bicomando per bidet con scarico Up&Down da 1"1/4

_Bidet mixer with 1"1/4 Up&Down waste

VASCA - DOCCIA
_BATH - SHOWER

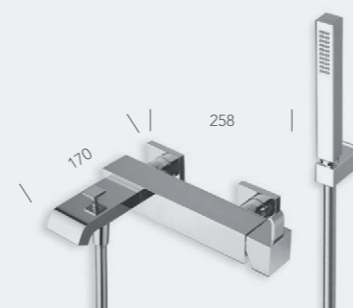

QM 100

Miscelatore monocomando per vasca esterno con flessibile LONG LIFE e doccetta anticalcare - Erogazione libera

_External bath mixer with LONG LIFE flexible hose and anti-lime hand shower - Free flow

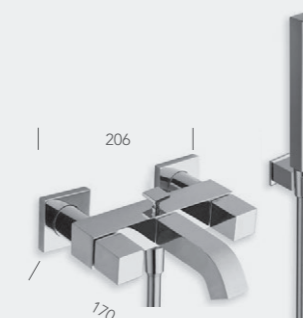

QD 100

Miscelatore bicomando per vasca esterno con flessibile LONG LIFE e doccetta anticalcare

_External bath mixer with LONG LIFE flexible hose and anti-lime hand shower

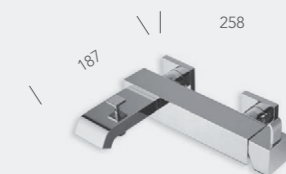

QM 107

Miscelatore monocomando per vasca esterno - Erogazione libera

_External bath mixer - Free flow

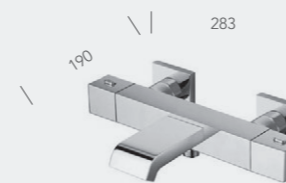

QD 187

Miscelatore termostatico "corpo freddo" per vasca esterno

_ "Cold touch" external thermostatic bath mixer



QD 188

Miscelatore termostatico "corpo freddo" per vasca esterno con colonna girevole, soffione SANDWICH SPECIAL 25x25 cm, doccetta anticalcare e flessibile LONG LIFE - Erogazione libera

_ "Cold touch" external thermostatic bath mixer with swivel column pipe, 25 x 25 cm SANDWICH SPECIAL overhead shower, anti-lime hand shower and LONG LIFE flexible hose - Free flow

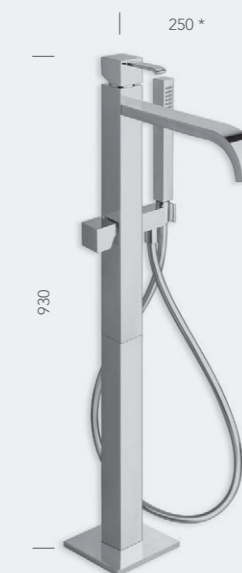

QM 189

Set da esterno per miscelatore monocomando vasca a pavimento CS 290 con flessibile LONG LIFE e doccetta anticalcare con miscelazione indipendente - Erogazione libera

_Floor mounted bath mixer external parts for CS 290 with LONG LIFE flexible hose and anti-lime hand shower with independent mixing - Free flow

* interasse corpo - bocca

QUADRI the range

CRISTINA

VASCA - DOCCIA
_BATH - SHOWER

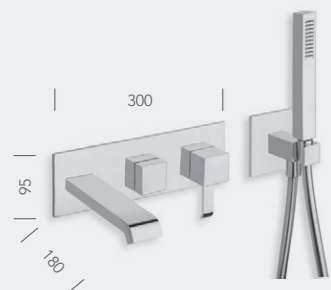

QM 102 | QM 103

Set da esterno per miscelatore monocomando doccia/vasca CS 100 (comando destro) - CS 101 (comando sinistro) con deviatore 2/3 uscite, doccetta anticalcare, flessibile LONG LIFE e piastra in metallo

_Bath/shower mixer external parts for CS 100 (right side) - CS 101 (left side) with 2 outlet diverter, anti-lime hand shower, LONG LIFE flexible hose and metal plate

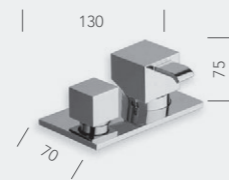

QM 129

Miscelatore monocomando per bordo vasca con deviatore 2 uscite e piastra in metallo

_Deck mounted bath mixer with 2 outlet diverter and metal plate

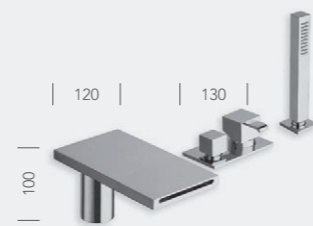

QM 181

Miscelatore monocomando per bordo vasca 4 fori con deviatore bocca erogazione, doccetta anticalcare estraibile, FOLLOW ME e piastra in metallo - Erogazione libera

_4 hole deck mounted bath mixer with diverter, spout, pull-out anti-lime hand shower, FOLLOW ME and metal plate - Free flow



QD 485

Miscelatore termostatico "corpo freddo" per doccia esterno con colonna girevole, soffione SANDWICH SPECIAL 25x25 cm, doccetta anticalcare con supporto scorrevole e flessibile LONG LIFE

_ "Cold touch" external thermostatic shower mixer with swivel column pipe, 25 x 25 cm SANDWICH SPECIAL overhead shower, anti-lime hand shower with slide rail and LONG LIFE flexible hose

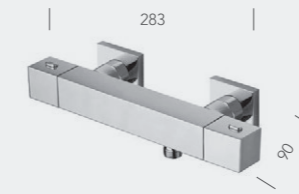

QD 481

Miscelatore termostatico "corpo freddo" per doccia esterno

_ "Cold touch" external thermostatic shower mixer

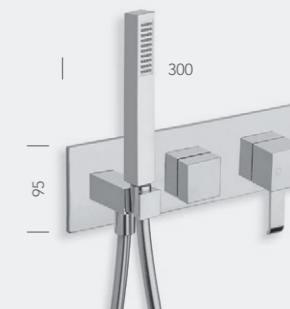

QM 602 | QM 603

Set da esterno per miscelatore monocomando doccia/vasca CS 100 (comando destro) - CS 101 (comando sinistro) con deviatore 2/3 uscite, doccetta anticalcare, flessibile LONG LIFE

_ Bath/shower mixer external parts for CS 100 (right side) - CS 101 (left side) with 2/3 outlet diverter, anti-lime hand shower, LONG LIFE flexible hose

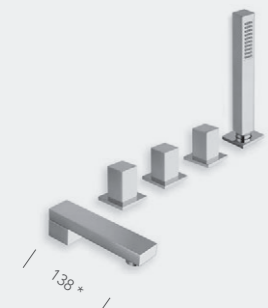

QD 121

Miscelatore bicomando per bordo vasca 5 fori con deviatore, bocca erogazione, doccetta anticalcare estraibile e FOLLOW ME

_5 hole deck mounted bath mixer with diverter, spout, pull-out anti-lime hand shower and FOLLOW ME

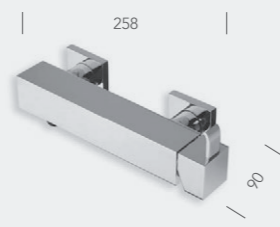

QM 401

Miscelatore monocomando per doccia esterno

_External shower mixer



QD 478

Miscelatore termostatico "corpo freddo" per doccia esterno con colonna girevole, soffione anticalcare ispezionabile, doccetta anticalcare con supporto scorrevole e flessibile LONG LIFE

_ "Cold touch" external thermostatic shower mixer with turning column pipe, checkable anti-lime overhead shower, anti-lime hand shower with slide rail and LONG LIFE flexible hose

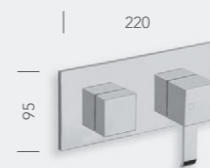

QM 611

Set completo per miscelatore monocomando doccia/vasca da incasso con deviatore 3 uscite e piastra in metallo

_Complete concealed bath/shower mixer with 3 outlet diverter and metal plate



QM 120

Set completo per miscelatore monocomando doccia/vasca da incasso con deviatore 3 uscite e piastra in metallo

_Complete concealed bath/shower mixer with 3 outlet diverter and metal plate

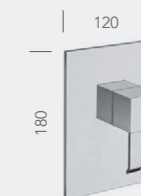

QM 686

Set da esterno per miscelatore monocomando doccia CS 535 con piastra in metallo

_Shower mixer external parts for CS 535 with metal plate

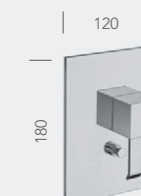

QM 689

Set da esterno per miscelatore monocomando doccia/vasca CS 535 con deviatore 2 uscite e piastra in metallo

_Bath/shower mixer external parts for CS 535 with 2 outlet diverter and metal plate

* interasse corpo - bocca

QUADRI S the range

CRISTINA

LAVABO - BIDET
_WASHBASIN - BIDET



QS 220

Miscelatore monocomando REGULAR per lavabo con scarico Up&Down da 1"1/4

_Basin mixer REGULAR with 1"1/4 Up&Down waste



QS 227

Miscelatore monocomando MEDIUM per lavabo con scarico Up&Down da 1"1/4

_Basin mixer MEDIUM with 1"1/4 Up&Down waste



QS 222

Miscelatore monocomando TALL per lavabo con scarico Up&Down da 1"1/4

_Basin mixer TALL with 1"1/4 Up&Down waste

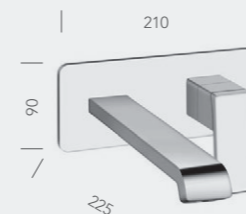

QS 258

Set da esterno miscelatore monocomando lavabo LARGE per CS 200 (comando destro) - CS 201 (comando sinistro) con scarico Up&Down da 1"1/4 e piastra in metallo

_Wall mounted basin mixer LARGE external parts for CS 200 (right side) - CS 201 (left side) with 1"1/4 Up&Down waste and metal plate

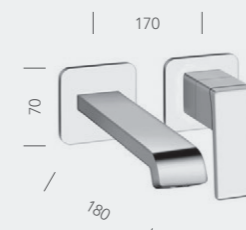

QS 257

Set da esterno miscelatore monocomando lavabo REGULAR per CS 200 (comando destro) - CS 201 (comando sinistro) con scarico Up&Down da 1"1/4

_Wall mounted basin mixer REGULAR external parts for CS 200 (right side) - CS 201 (left side) with 1"1/4 Up&Down waste

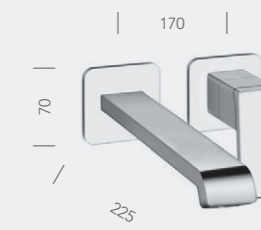

QS 259

Set da esterno miscelatore monocomando lavabo LARGE per CS 200 (comando destro) - CS 201 (comando sinistro) con scarico Up&Down da 1"1/4

_Wall mounted basin mixer LARGE external parts for CS 200 (right side) - CS 201 (left side) with 1"1/4 Up&Down waste



QS 264

Miscelatore monocomando LARGE per lavabo con scarico Up&Down da 1"1/4

_Basin mixer LARGE with 1"1/4 Up&Down waste



QS 290

Set da esterno per miscelatore monocomando lavabo a pavimento CS 290 con scarico Up&Down da 1"1/4

_Floor mounted basin mixer external parts for CS 290 with 1"1/4 Up&Down waste

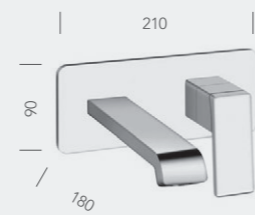

QS 256

Set da esterno miscelatore monocomando lavabo REGULAR per CS 200 (comando destro) - CS 201 (comando sinistro) con scarico Up&Down da 1"1/4 e piastra in metallo

_Wall mounted basin mixer REGULAR external parts for CS 200 (right side) - CS 201 (left side) with 1"1/4 Up&Down waste and metal plate



QS 320

Miscelatore monocomando per bidet con scarico Up&Down da 1"1/4

_Bidet mixer with 1"1/4 Up&Down waste

* interasse corpo - bocca

QUADRI S the range

CRISTINA

VASCA - DOCCIA
_BATH - SHOWER



QS 100

Miscelatore monocomando per vasca esterno con flessibile LONG LIFE e doccetta anticalcare

_External bath mixer with LONG LIFE flexible hose and anti-lime hand shower

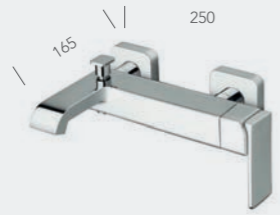

QS 107

Miscelatore monocomando per vasca esterno

_ External bath mixer



QS 189

Set da esterno per miscelatore monocomando vasca a pavimento CS 290 con flessibile LONG LIFE e doccetta anticalcare con miscelazione indipendente

_Floor mounted bath mixer external parts for CS 290 with LONG LIFE flexible hose and anti-lime hand shower with independent mixing



QS 409

Miscelatore monocomando per doccia esterno con colonna girevole, soffione SANDWICH SPECIAL 25 x 25 cm, flessibile LONG LIFE e doccetta anticalcare con supporto scorrevole

_ External shower mixer with swivel column pipe, 25 x 25 cm SANDWICH SPECIAL overhead shower, LONG LIFE flexible hose and anti-lime hand shower with slide rail

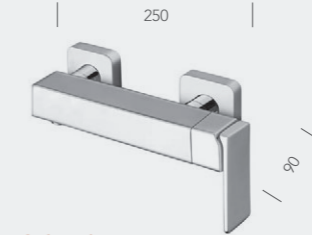

QS 401

Miscelatore monocomando per doccia esterno

_External shower mixer

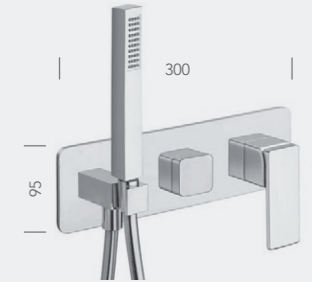

QS 602 | QS 603

Set da esterno per miscelatore monocomando doccia/vasca CS 100 (comando destro) - CS 101 (comando sinistro) con deviatore 2/3 uscite, doccetta anticalcare, flessibile LONG LIFE

_ Bath/shower mixer external parts for CS 100 (right side) - CS 101 (left side) with 2/3 outlet diverter, anti-lime hand shower, LONG LIFE flexible hose

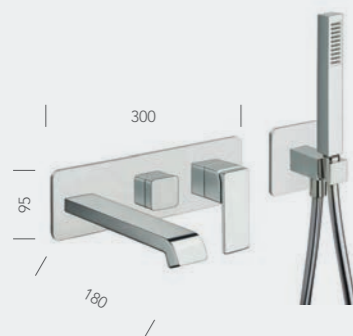

QS 102 | QS 103

Set da esterno per miscelatore monocomando doccia/vasca CS 100 (comando destro) - CS 101 (comando sinistro) con deviatore 2/3 uscite, doccetta anticalcare, flessibile LONG LIFE e piastra in metallo

_ Bath/shower mixer external parts for CS 100 (right side) - CS 101 (left side) with 2/3 outlet diverter, anti-lime hand shower, LONG LIFE flexible hose and metal plate

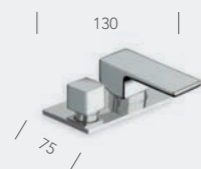

QS 129

Miscelatore monocomando per bordo vasca con deviatore 2 uscite e piastra in metallo

_Deck mounted bath mixer with 2 outlet diverter and metal plate



QS 181

Miscelatore monocomando per bordo vasca 4 fori con deviatore bocca erogazione, doccetta anticalcare estraibile, FOLLOW ME e piastra in metallo - Erogazione libera

_4 hole deck mounted bath mixer with diverter, spout, pull-out anti-lime hand shower, FOLLOW ME and metal plate - Free flow

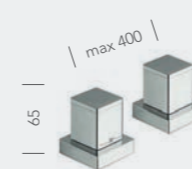

XQ 142 | XQ 143

Miscelatore termostatico per bordo vasca con deviatore 2/3 uscite

_ Deck mounted thermostatic bath mixer with 2/3 outlets diverter



QS 638

Set completo per miscelatore monocomando doccia da incasso con piastra in metallo

_Complete concealed shower mixer with metal plate



QS 683

Set completo gruppo deviatore 2 uscite da incasso con piastra in metallo

_Complete concealed 2 outlet diverter kit with metal plate

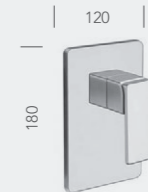

QS 686

Set da esterno per miscelatore monocomando doccia/vasca CS 535 con piastra in metallo

_Shower mixer external parts for CS 535 with metal plate



QS 689

Set da esterno per miscelatore monocomando doccia/vasca CS 535 con deviatore 2 uscite e piastra in metallo

_Bath/shower mixer external parts for CS 535 with 2 outlet diverter and metal plate

* interasse corpo - bocca

QUEEN the range

CRISTINA

LAVABO - BIDET
_WASHBASIN - BIDET



QE 220

Miscelatore monocomando REGULAR per lavabo con scarico Up&Down da 1"1/4

_Basin mixer REGULAR with 1"1/4 Up&Down waste



QE 210

Miscelatore monocomando REGULAR per lavabo con scarico Up&Down da 1"1/4

_Basin mixer REGULAR with 1"1/4 Up&Down waste



QE 227

Miscelatore monocomando MEDIUM per lavabo con scarico Up&Down da 1"1/4

_Basin mixer MEDIUM with 1"1/4 Up&Down waste

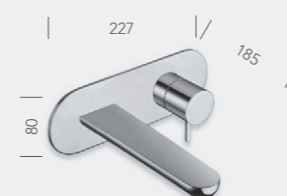

QE 256

Set da esterno miscelatore monocomando lavabo REGULAR per CS 200 (comando destro) - CS 201 (comando sinistro) con scarico Up&Down da 1"1/4 e piastra in metallo

_Wall mounted basin mixer REGULAR external parts for CS 200 (right side) - CS 201 (left side) with 1"1/4 Up&Down waste and metal plate

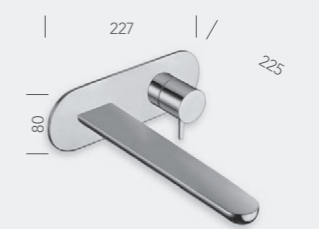

QE 258

Set da esterno miscelatore monocomando lavabo LARGE per CS 200 (comando destro) - CS 201 (comando sinistro) con scarico Up&Down da 1"1/4 e piastra in metallo

_Wall mounted basin mixer LARGE external parts for CS 200 (right side) - CS 201 (left side) with 1"1/4 Up&Down waste and metal plate



QE 320

Miscelatore monocomando per bidet con scarico Up&Down da 1"1/4

_Bidet mixer with 1"1/4 Up&Down waste



QE 217

Miscelatore monocomando MEDIUM per lavabo con scarico Up&Down da 1"1/4

_Basin mixer MEDIUM with 1"1/4 Up&Down waste



QE 222

Miscelatore monocomando TALL per lavabo con scarico Up&Down da 1"1/4

_Basin mixer TALL with 1"1/4 Up&Down waste



QE 212

Miscelatore monocomando TALL per lavabo con scarico Up&Down da 1"1/4

_Basin mixer TALL with 1"1/4 Up&Down waste



QE 310

Miscelatore monocomando per bidet con scarico Up&Down da 1"1/4

_Bidet mixer with 1"1/4 Up&Down waste

* interasse corpo - bocca

QUEEN the range

CRISTINA

VASCA - DOCCIA
_BATH - SHOWER

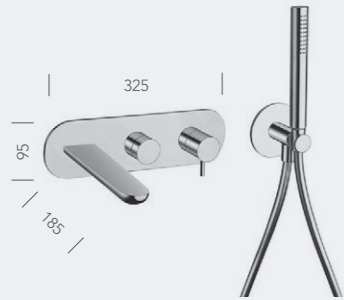

QE 102 | QE 103

Set da esterno per miscelatore monocomando doccia/vasca CS 100 (comando destro) - CS 101 (comando sinistro) con deviatore 2/3 uscite, doccetta anticalcare in ottone, flessibile LONG LIFE e piastra in metallo

_Bath/shower mixer external parts for CS 100 (right side) - CS 101 (left side) with 2/3 outlet diverter, LONG LIFE flexible hose, brass anti-lime hand shower and metal plate



QE 686

Set da esterno per miscelatore monocomando doccia CS 535 con piastra in metallo

_Shower mixer external parts for CS 535 with metal plate



QE 689

Set da esterno per miscelatore monocomando doccia/vasca CS 535 con deviatore 2 uscite e piastra in metallo

_Bath/shower mixer external parts for CS 535 with 2 outlet diverter and metal plate

RUBINETTO the range

LAVABO - BIDET
_WASHBASIN - BIDET



RU 220

Miscelatore monocomando REGULAR per lavabo con scarico Up&Down da 1"1/4

_Basin mixer REGULAR with 1"1/4 Up&Down waste



RU 224

Miscelatore monocomando REGULAR per lavabo con scarico Up&Down da 1"1/4

_Basin mixer REGULAR with 1"1/4 Up&Down waste



RU 229

Miscelatore monocomando MEDIUM per lavabo con scarico Up&Down da 1"1/4

_Basin mixer MEDIUM with 1"1/4 Up&Down waste



RU 233

Set completo per miscelatore monocomando lavabo LARGE da incasso con scarico Up&Down da 1"1/4

_Complete wall mounted basin mixer LARGE with 1"1/4 Up&Down waste



RU 290

Set da esterno per miscelatore monocomando lavabo a pavimento CS 290 con scarico Up&Down da 1"1/4

_Floor mounted basin mixer external parts for CS 290 with 1"1/4 Up&Down waste



RU 228

Miscelatore monocomando TALL per lavabo con scarico Up&Down da 1"1/4

_Basin mixer TALL with 1"1/4 Up&Down waste



RU 256

Set da esterno miscelatore monocomando lavabo REGULAR per CS 200 (comando destro) con scarico Up&Down da 1"1/4 e piastra in metallo

_Wall mounted basin mixer REGULAR external parts for CS 200 (right side) with 1"1/4 Up&Down waste and metal plate



RU 232

Set completo per miscelatore monocomando lavabo REGULAR da incasso con scarico Up&Down da 1"1/4

_Complete wall mounted basin mixer REGULAR with 1"1/4 Up&Down waste



RU 320

Miscelatore monocomando per bidet con scarico Up&Down da 1"1/4

_Bidet mixer with 1"1/4 Up&Down waste



RU 324

Miscelatore monocomando per bidet con scarico Up&Down da 1"1/4

_Bidet mixer with 1"1/4 Up&Down waste

* interasse corpo - bocca

RUBINETTO the range

VASCA - DOCCIA
_BATH - SHOWER

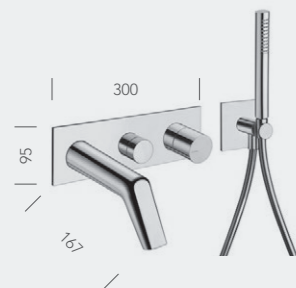

RU 102 | RU 103

Set da esterno per miscelatore monocomando doccia/vasca CS 100 (comando destro) - CS 101 (comando sinistro) con deviatore 2/3 uscite, doccetta anticalcare, flessibile LONG LIFE e piastra in metallo

_Bath/shower mixer external parts for CS 100 (right side) - CS 101 (left side) with 2/3 outlet diverter, LONG LIFE flexible hose, anti-lime hand shower and metal plate

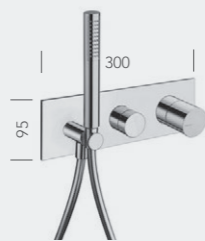

RU 602 | RU 603

Set da esterno per miscelatore monocomando doccia/vasca CS 100 (comando destro) - CS 101 (comando sinistro) con deviatore 2/3 uscite, doccetta anticalcare, flessibile LONG LIFE e piastra in metallo

_Bath/shower mixer external parts for CS 100 (right side) - CS 101 (left side) with 2/3 outlet diverter, LONG LIFE flexible hose, anti-lime hand shower and metal plate



RU 190

Set da esterno per miscelatore monocomando vasca a pavimento CS 290 con flessibile LONG LIFE e doccetta anticalcare con miscelazione indipendente

_Floor mounted bath mixer external parts for CS 290 with LONG LIFE flexible hose and anti-lime hand shower with independent mixing



RU 686

Set da esterno per miscelatore monocomando doccia CS 535 con piastra in metallo

_Shower mixer external parts for CS 535 with metal plate



RU 689

Set da esterno per miscelatore monocomando doccia/vasca CS 535 con deviatore 2 uscite e piastra in metallo

_Bath/shower mixer external parts for CS 535 with 2 outlet diverter and metal plate

TABULA the range

LAVABO - BIDET
_WASHBASIN - BIDET



TA 220

Miscelatore monocomando REGULAR per lavabo con scarico Up&Down da 1"1/4

_Basin mixer REGULAR with 1"1/4 Up&Down waste



TA 227

Miscelatore monocomando MEDIUM per lavabo con scarico Up&Down da 1"1/4

_Basin mixer MEDIUM with 1"1/4 Up&Down waste

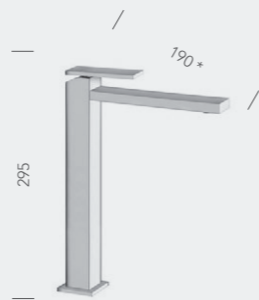

TA 222

Miscelatore monocomando TALL per lavabo con scarico Up&Down da 1"1/4

_Basin mixer TALL with 1"1/4 Up&Down waste

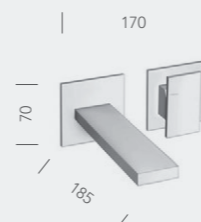

TA 257

Set da esterno miscelatore monocomando lavabo REGULAR per CS 200 (comando destro) - CS 201 (comando sinistro) con scarico Up&Down da 1"1/4 e piastra in metallo

_Wall mounted basin mixer REGULAR external parts for CS 200 (right side) - CS 201 (left side) with 1"1/4 Up&Down waste and metal plate

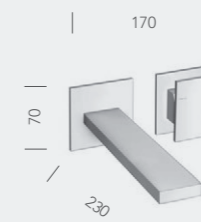

TA 259

Set da esterno miscelatore monocomando lavabo LARGE per CS 200 (comando destro) - CS 201 (comando sinistro) con scarico Up&Down da 1"1/4 e piastra in metallo

_Wall mounted basin mixer LARGE external parts for CS 200 (right side) - CS 201 (left side) with 1"1/4 Up&Down waste and metal plate

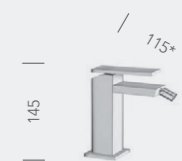

TA 320

Miscelatore monocomando per bidet con scarico Up&Down da 1"1/4

_Bidet mixer with 1"1/4 Up&Down waste

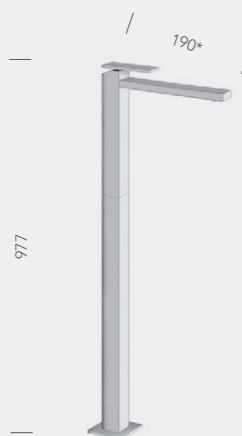

TA 290

Set da esterno per miscelatore monocomando lavabo a pavimento CS 290 con scarico Up&Down da 1"1/4

_Floor mounted basin mixer external parts for CS 290 with 1"1/4 Up&Down waste

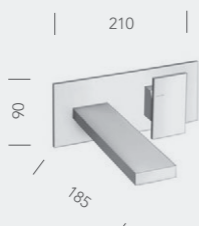

TA 256

Set da esterno miscelatore monocomando lavabo REGULAR per CS 200 (comando destro) - CS 201 (comando sinistro) con scarico Up&Down da 1"1/4 e piastra in metallo

_Wall mounted basin mixer REGULAR external parts for CS 200 (right side) - CS 201 (left side) with 1"1/4 Up&Down waste and metal plate

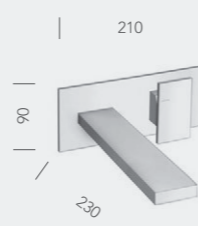

TA 258

Set da esterno miscelatore monocomando lavabo LARGE per CS 200 (comando destro) - CS 201 (comando sinistro) con scarico Up&Down da 1"1/4 e piastra in metallo

_Wall mounted basin mixer LARGE external parts for CS 200 (right side) - CS 201 (left side) with 1"1/4 Up&Down waste and metal plate

* interasse corpo - bocca

TABULA the range

VASCA - DOCCIA
_BATH - SHOWER

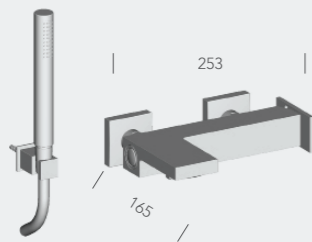

TA 100

Miscelatore monocomando per vasca esterno con flessibile LONG LIFE e doccetta anticalcare

_External bath mixer with LONG LIFE flexible hose and anti-lime hand shower

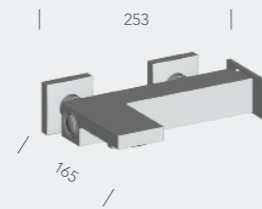

TA 107

Miscelatore monocomando per vasca esterno

_External bath mixer

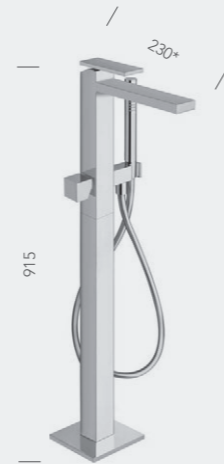

TA 189

Set da esterno per miscelatore monocomando vasca a pavimento CS 290 con flessibile LONG LIFE e doccetta anticalcare con miscelazione indipendente

_Floor mounted bath mixer external parts for CS 290 with LONG LIFE flexible hose and anti-lime hand shower with independent mixing



TA 409

Miscelatore monocomando per doccia esterno con colonna girevole, soffione SANDWICH SPECIAL ø 25 cm, flessibile LONG LIFE e doccetta anticalcare con supporto scorrevole

_ External shower mixer with swivel column pipe, ø 25 cm SANDWICH SPECIAL overhead shower, LONG LIFE flexible hose and anti-lime hand shower with slide rail

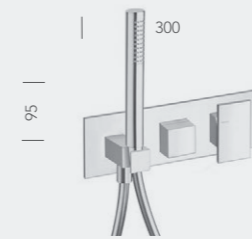

TA 602| 603

Set da esterno per miscelatore monocomando doccia/vasca CS 100 (comando destro) - CS 101 (comando sinistro) con deviatore 2/3 uscite, doccetta anticalcare, flessibile LONG LIFE

_Bath/shower mixer external parts for CS 100 (right side) - CS 101 (left side) with 2/3 outlet diverter, anti-lime hand shower, LONG LIFE flexible hose



TA 638

Set completo per miscelatore monocomando doccia da incasso con piastra in metallo

_ Complete concealed shower mixer with metal plate

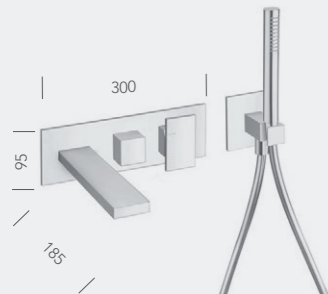

TA 102 | 103

Set completo per miscelatore monocomando doccia/vasca CS100 (comando destro) con deviatore 2/3 uscite, doccetta anticalcare, flessibile LONG LIFE e piastra in metallo

_Complete concealed bath/shower mixer CS100 (right side) with 2/3 outlet diverter, anti-lime hand shower, LONG LIFE flexible hose and metal plate

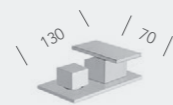

TA 129

Miscelatore monocomando per bordo vasca con deviatore 2 uscite e piastra in metallo

_Deck mounted bath mixer with 2 outlet diverter and metal plate

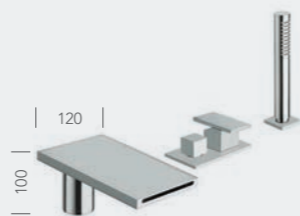

TA 181

Miscelatore monocomando per bordo vasca 4 fori con deviatore, bocca erogazione, doccetta anticalcare estraibile, FOLLOW ME e piastra in metallo- Erogazione libera

_4 hole deck mounted bath mixer with diverter, spout, pull-out antilime hand shower, FOLLOW ME and metal plate - Free flow



TA 686

Set da esterno per miscelatore monocomando doccia/vasca CS 535 con piastra in metallo

_ Bath/shower mixer external parts for CS 535 with metal plate



TA 689

Set da esterno per miscelatore monocomando doccia CS 535 con deviatore 2 uscite e piastra in metallo

_Shower mixer external parts for CS 535 with 2 outlet diverter and metal plate

* interasse corpo - bocca

TRICOLORE VERDE the range

LAVABO - BIDET
_WASHBASIN - BIDET



TV 220

Miscelatore monocomando REGULAR per lavabo con scarico Up&Down da 1"1/4

_Basin mixer REGULAR with 1"1/4 Up&Down waste



TV 227

Miscelatore monocomando MEDIUM per lavabo con scarico Up&Down da 1"1/4

_Basin mixer MEDIUM with 1"1/4 Up&Down waste



TV 222

Miscelatore monocomando TALL per lavabo con scarico Up&Down da 1"1/4

_Basin mixer TALL with 1"1/4 Up&Down waste



TV 229

Miscelatore bicomando MEDIUM per lavabo con scarico Up&Down da 1"1/4

_Basin mixer MEDIUM with 1"1/4 Up&Down waste



TV 249

Miscelatore bicomando TALL per lavabo con scarico Up&Down da 1"1/4

_Basin mixer TALL with 1"1/4 Up&Down waste



TV 224

Miscelatore monocomando REGULAR per lavabo 2 fori con scarico Up&Down da 1"1/4

_2 hole basin mixer REGULAR with 1"1/4 Up&Down waste



TV 290

Set da esterno per miscelatore monocomando lavabo a pavimento CS 290 con scarico Up&Down da 1"1/4

_Floor mounted basin mixer external parts for CS 290 with 1"1/4 Up&Down waste



TV 264

Miscelatore monocomando REGULAR per lavabo con scarico Up&Down da 1"1/4

_Basin mixer REGULAR with 1"1/4 Up&Down waste



TV 226

Miscelatore bicomando REGULAR per lavabo con scarico Up&Down da 1"1/4

_Basin mixer REGULAR with 1"1/4 Up&Down waste



TV 265

Miscelatore monocomando REGULAR per lavabo con bocca incasso e scarico Up&Down da 1"1/4

_Basin mixer REGULAR with wall mounted spout and 1"1/4 Up&Down waste



TV 256

Set da esterno miscelatore monocomando lavabo REGULAR per CS 200 (comando destro) - CS 201 (comando sinistro) con scarico Up&Down da 1"1/4 e piastra in metallo

_Wall mounted basin mixer REGULAR external parts for CS 200 (right side) - CS 201 (left side) with 1"1/4 Up&Down waste and metal plate



TV 258

Set da esterno miscelatore monocomando lavabo LARGE per CS 200 (comando destro) - CS 201 (comando sinistro) con scarico Up&Down da 1"1/4 e piastra in metallo

_Wall mounted basin mixer LARGE external parts for CS 200 (right side) - CS 201 (left side) with 1"1/4 Up&Down waste and metal plate

* interasse corpo - bocca

TRICOLORE VERDE the range

CRISTINA

LAVABO - BIDET
_WASHBASIN - BIDET



TV 257

Set da esterno miscelatore monocomando lavabo REGULAR per CS 200 (comando destro) - CS 201 (comando sinistro) con scarico Up&Down da 1"1/4

_Wall mounted basin mixer REGULAR external parts for CS 200 (right side) - CS 201 (left side) with 1"1/4 Up&Down waste



TV 259

Set da esterno miscelatore monocomando lavabo LARGE per CS 200 (comando destro) - CS 201 (comando sinistro) con scarico Up&Down da 1"1/4

_Wall mounted basin mixer LARGE external parts for CS 200 (right side) - CS 201 (left side) with 1"1/4 Up&Down waste



TV 240

Rubinetto "acqua fredda" da 1/2"

_1/2" "cold water" tap



TV 320

Miscelatore monocomando per bidet con scarico Up&Down da 1"1/4

_Bidet mixer with 1"1/4 Up&Down waste



TV 326

Miscelatore monocomando per bidet con scarico Up&Down da 1"1/4

_Bidet mixer with 1"1/4 Up&Down waste



TV 364

Miscelatore monocomando per bidet con scarico Up&Down da 1"1/4

_Bidet mixer with 1"1/4 Up&Down waste



TV 241

Rubinetto "acqua fredda" da 1/2"

_1/2" "cold water" tap

* interasse corpo - bocca

TRICOLORE VERDE the range

CRISTINA

VASCA - DOCCIA
_BATH - SHOWER



TV 180

Miscelatore monocomando per vasca esterno con flessibile LONG LIFE e doccetta anticalcare

_External bath mixer with LONG LIFE flexible hose and anti-lime hand shower



TV 187

Miscelatore monocomando per vasca esterno

_ External bath mixer

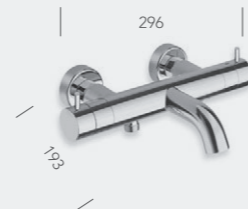

TV 157

Miscelatore termostatico "corpo freddo" per vasca esterno

_ "Cold touch" external thermostatic bath mixer



TV 132

Miscelatore monocomando per bordo vasca con 1 uscita da 1/2"

_Deck mounted bath mixer with 1 outlet 1/2"



TV 121

Miscelatore monocomando per bordo vasca 2 fori con deviatore, doccetta anticalcare estraibile e FOLLOW ME

_2 hole deck mounted bath mixer with diverter, pull-out anti-lime hand shower and FOLLOW ME

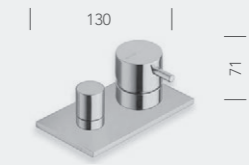

TV 129

Miscelatore monocomando per bordo vasca con deviatore 2 uscite e piastra in metallo

_Deck mounted bath mixer with 2 outlet diverter and metal plate



TV 189

Set da esterno per miscelatore monocomando vasca a pavimento CS 290 con flessibile LONG LIFE e doccetta anticalcare con miscelazione indipendente

_Floor mounted bath mixer external parts for CS 290 with LONG LIFE flexible hose and anti-lime hand shower with independent mixing

* interasse corpo - bocca

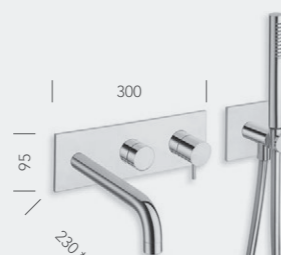

TV 102 | TV 103

Set da esterno per miscelatore monocomando doccia/vasca CS 100 (comando destro) - CS 101 (comando sinistro) con deviatore 2/3 uscite, doccetta anticalcare, flessibile LONG LIFE e piastra in metallo

_Bath/shower mixer external parts for CS 100 (right side) - CS 101 (left side) with 2/3 outlet diverter, LONG LIFE flexible hose, anti-lime hand shower and metal plate



TV 138

Set da esterno per miscelatore monocomando vasca CS 100 (comando destro) - CS 101 (comando sinistro) con deviatore

_ Wall mounted bath mixer external parts for CS 100 (right side) - CS 101 (left side) diverter



XT 142 | XT 143

Miscelatore termostatico per bordo vasca con deviatore 2/3 uscite

_ Deck mounted thermostatic bath mixer with 2/3 outlets diverter



TV 133

Miscelatore bicomando per bordo vasca con deviatore 2 uscite e piastra in metallo

_Deck mounted bath mixer with 2 outlet diverter and metal plate



TV 122

Miscelatore bicomando per bordo vasca 4 fori con doccetta anticalcare estraibile, deviatore 2 uscite e FOLLOW ME,

_4 hole deck mounted bath mixer with pull-out anti-lime hand shower, 2 outlets diverter and FOLLOW ME

TRICOLORE VERDE the range

CRISTINA

VASCA - DOCCIA
_BATH - SHOWER

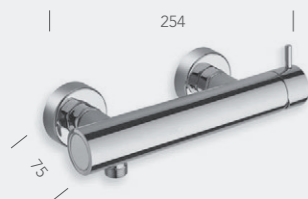

TV 481

Miscelatore monocomando per doccia esterno

_ External shower mixer

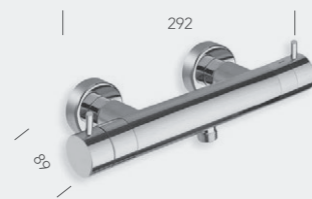

TV 451

Miscelatore termostatico per doccia esterno

_ External thermostatic shower mixer

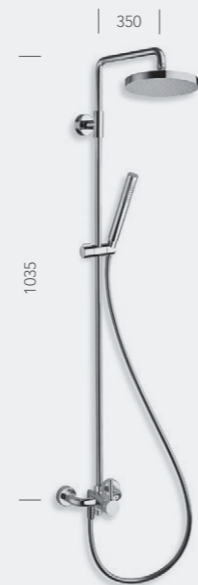

TV 409

Miscelatore monocomando per doccia esterno con colonna girevole, soffione anticalcare ispezionabile, flessibile LONG LIFE e doccetta anticalcare con supporto scorrevole

_ External shower mixer with swivel column pipe, checkable anti-lime overhead shower, LONG LIFE flexible hose and anti-lime hand shower with slide rail

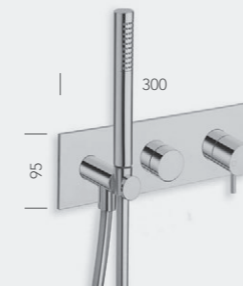

TV 602 | TV 603

Set da esterno per miscelatore monocomando doccia/vasca CS 100 (comando destro) - CS 101 (comando sinistro) con deviatore 2/3 uscite, doccetta anticalcare, flessibile LONG LIFE

_ Bath/shower mixer external parts for CS 100 (right side) - CS 101 (left side) with 2/3 outlet diverter, anti-lime hand shower, LONG LIFE flexible hose

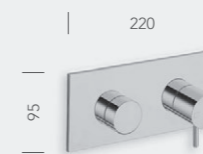

TV 611

Set completo per miscelatore monocomando doccia/vasca da incasso con deviatore 3 uscite e piastra in metallo

_ Complete concealed bath/shower mixer with 3 outlet diverter and metal plate

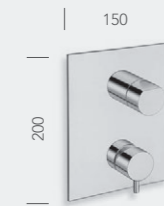

TV 120

Set completo per miscelatore monocomando doccia/vasca da incasso con deviatore 3 uscite e piastra in metallo

_ Complete concealed bath/shower mixer with 3 outlet diverter and metal plate

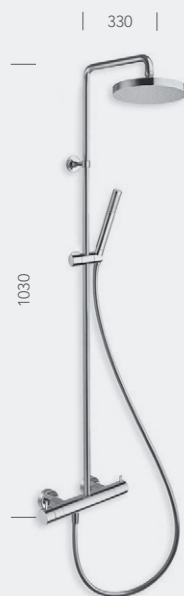

TV 486

Miscelatore termostatico per doccia esterno con colonna girevole, soffione anticalcare ispezionabile, doccetta anticalcare con supporto scorrevole e flessibile LONG LIFE

_ External thermostatic shower mixer with turning column pipe, checkable anti-lime overhead shower, anti-lime hand shower with slide rail and LONG LIFE flexible hose



TV 457

Miscelatore termostatico per doccia esterno con colonna e deviatore 3+1 uscite, soffione anticalcare ispezionabile, flessibile LONG LIFE, doccetta anticalcare con supporto scorrevole, getti anticalcare orientabili, uscita combinata soffione e getti

_ External thermostatic shower mixer with column and 3+1 outlets diverter, checkable showerhead, LONG LIFE flexible hose, anti-lime hand shower, adjustable anti-lime water jets and combined shower head/jets outlet



TV 415

Miscelatore termostatico per doccia esterno con soffione anticalcare ispezionabile, flessibile LONG LIFE e doccetta anticalcare

_ External thermostatic shower mixer with checkable overhead shower, LONG LIFE flexible hose and anti-lime hand shower



TV 686

Set da esterno per miscelatore monocomando doccia CS 535 con piastra in metallo

_ Shower mixer external parts for CS 535 with metal plate



TV 689

Set da esterno per miscelatore monocomando doccia/vasca CS 535 con deviatore 2 uscite e piastra in metallo

_ Bath/shower mixer external parts for CS 535 with 2 outlet diverter and metal plate



TV 638

Set completo per miscelatore monocomando doccia da incasso con piastra in metallo

_ Complete concealed shower mixer with metal plate



TV 683

Set completo gruppo deviatore 2 uscite da incasso con piastra in metallo

_ Complete concealed 2 outlet diverter kit with metal plate



TV 620

Rubinetto d'arresto da 1/2"

_ 1/2" stopcock



TV 621

Rubinetto d'arresto da 3/4"

_ 3/4" stopcock

UNIC the range

LAVABO - BIDET
_WASHBASIN - BIDET



UC 220

Miscelatore monocomando REGULAR per lavabo con scarico Up&Down da 1"1/4

_Basin mixer REGULAR with 1"1/4 Up&Down waste



UC 227

Miscelatore monocomando MEDIUM per lavabo con scarico Up&Down da 1"1/4

_Basin mixer MEDIUM with 1"1/4 Up&Down waste



UC 222

Miscelatore monocomando TALL per lavabo con scarico Up&Down da 1"1/4

_Basin mixer TALL with 1"1/4 Up&Down waste



UC 320

Miscelatore monocomando per bidet con scarico Up&Down da 1"1/4

_Bidet mixer with 1"1/4 Up&Down waste



UC 223

Miscelatore monocomando LARGE per lavabo con scarico Up&Down da 1"1/4

_Basin mixer LARGE with 1"1/4 Up&Down waste

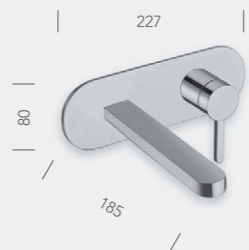

UC 256

Set da esterno miscelatore monocomando lavabo REGULAR per CS 200 (comando destro) - CS 201 (comando sinistro) con scarico Up&Down da 1"1/4 e piastra in metallo

_Wall mounted basin mixer REGULAR external parts for CS 200 (right side) - CS 201 (left side) with 1"1/4 Up&Down waste and metal plate

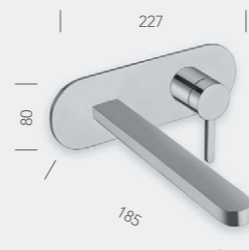

UC 258

Set da esterno miscelatore monocomando lavabo LARGE per CS 200 (comando destro) - CS 201 (comando sinistro) con scarico Up&Down da 1"1/4 e piastra in metallo

_Wall mounted basin mixer LARGE external parts for CS 200 (right side) - CS 201 (left side) with 1"1/4 Up&Down waste and metal plate

*interasse corpo - bocca

UNIC the range

CRISTINA

VASCA - DOCCIA
_BATH - SHOWER

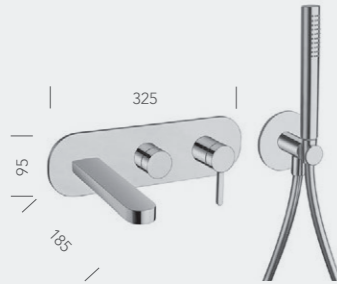

UC 102 | UC 103

Set da esterno per miscelatore monocomando doccia/vasca CS 100 (comando destro) - CS 101 (comando sinistro) con deviatore 2/3 uscite, doccetta anticalcare in ottone, flessibile LONG LIFE e piastra in metallo

_Bath/shower mixer external parts for CS 100 (right side) - CS 101 (left side) with 2/3 outlet diverter, brass anti-lime hand shower, LONG LIFE flexible hose and metal plate



UC 686

Set da esterno per miscelatore monocomando doccia CS 535 con piastra in metallo

_Shower mixer external parts for CS 535 with metal plate



UC 689

Set da esterno per miscelatore monocomando doccia/vasca CS 535 con deviatore 2 uscite e piastra in metallo

_Bath/shower mixer external parts for CS 535 with 2 outlet diverter and metal plate



WJ 675

Rubinetto singolo per wc/bidet esterno con flessibile LONG LIFE e doccetta con chiusura

_WC/bidet douche handset and wall mounted bracket with LONG LIFE flexible hose



WJ 676

Miscelatore monocomando per wc/bidet esterno con flessibile LONG LIFE e doccetta con chiusura

_WC/bidet mixer valve with integrated douche handset holder and LONG LIFE flexible hose



WJ 660

Set completo per miscelatore monocomando wc/bidet da incasso con flessibile LONG LIFE, piastra in metallo e doccetta con chiusura

_WC/bidet mixer valve with douche handset, metal plate and wall mounted bracket with LONG LIFE flexible hose

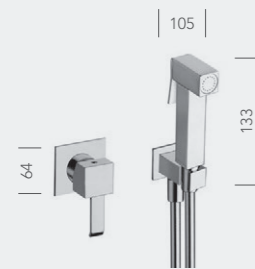

WJ 661

Set completo per miscelatore monocomando wc/bidet da incasso con flessibile LONG LIFE, piastra in metallo e doccetta con chiusura

_WC/bidet mixer valve with douche handset, metal plate and wall mounted bracket with LONG LIFE flexible hose



WJ 673

Miscelatore monocomando progressivo per wc/bidet esterno con flessibile LONG LIFE e doccetta con chiusura

_WC/bidet progressive mixer valve with integrated douche handset holder and LONG LIFE flexible hose



FINISHINGS

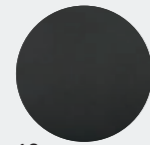

13
Nero opaco
Black matt
RAL 9005

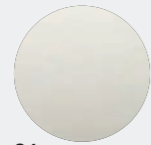

24
Bianco opaco
White matt
RAL 9016



34
Oro rosa spazzolato
Brushed rose gold



46
Oro rosa lucido
Polished rose gold

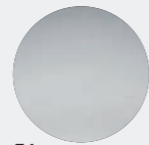

51
Cromato
Chrome



52
Oro giallo
Yellow gold

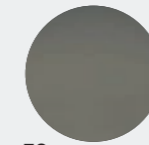

72
Cromo nero lucido
Polished black chrome

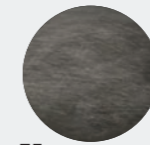

75
Cromo nero spazzolato
Brushed black chrome



77
Metallic spazzolato
Brushed metallic

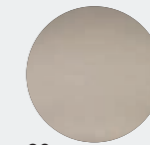

80
Metallic lucido
Polished metallic

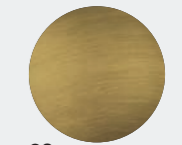

92
Ottone antico spazzolato
Brushed old brass

BEAK					●	
BOLLICINE					●	●
DELTA	●	●			●	
DIARIO	●	●			●	
EXCLUSIVE	●	●	●	●	●	●
* ITALY			●	●	●	●
KING					●	
OMEGA	●	●			●	
PiC	●	●			●	
PROFILO	●	●	●	●	●	
QUADRI	●	●			●	
QUADRI S	●	●	●	●	●	
QUEEN					●	
RUBINETTO	●	●			●	
TABULA						
TRICOLORE VERDE	●	●	●	●	●	●
UNIC					●	

BEAK					
BOLLICINE					
DELTA					
DIARIO					
EXCLUSIVE	●	●	●	●	●
ITALY	●	●	●	●	
KING					
OMEGA					
PiC					
PROFILO	●	●	●	●	
QUADRI					
QUADRI S	●	●	●	●	
QUEEN					
RUBINETTO					
TABULA					
TRICOLORE VERDE	●	●	●	●	●
UNIC					

* ITALY

La serie ITALY, oltre alla scelta total look nelle finiture proposte, offre la possibilità di abbinare al corpo del rubinetto in finitura le manopole in marmo o pietra.

The ITALY range, in addition to the suggested total look finishes, offers several possibilities to combine handles in marble or stone to the body in the various finishes.



QZ
Quarzite Velvet
Quartzite Velvet

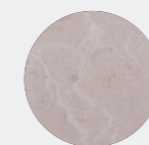

CR
Crema Nuova Velvet
Crema Nuova Velvet

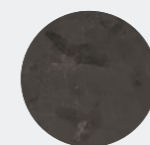

GF
Grafite lucida
Polished Graphite

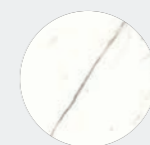

CC
Calacatta lucido
Polished Calacatta

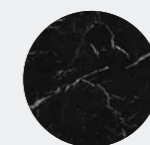

MQ
Marquinia lucido
Polished Marquinia

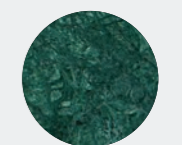

VG
Guatemala lucido
Polished Guatemala

CLASSIC LINES

CORPI SINUOSI CHE RIEVOCANO UN GUSTO CLASSICO E INTRAMONTABILE.

_CURVED SHAPES WHICH EVOKE A TIMELESS, CLASSIC STYLE.

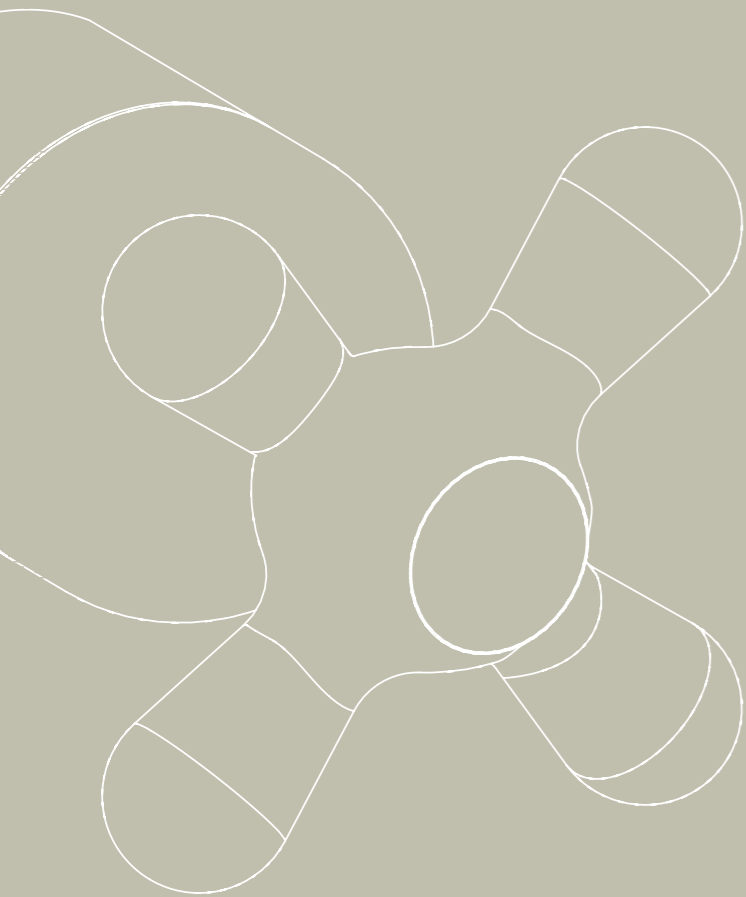

ART	p. 226
ART ELITE	p. 230
CANOVA	p. 232
IMPERO	p. 236
LONDRA	p. 240
WC JET	p. 244
THE RANGE Technical Specifications	p. 246

ART

—

L'armoniosa fusione tra linea classica e tecnica moderna fanno della serie un raffinato oggetto d'arredamento, ma di pratico uso quotidiano. Le forme morbide sinuose la rendono adatta ad ambienti bagno evoluti e al tempo stesso ricercati ed eleganti.

_The harmonious blend of classic lines and modern technology make the series a fine piece of design, but practical for everyday use. The soft, sinuous shapes make it perfect for contemporary bathrooms that at the same time refined and elegant.



AR 231



ART ELITE



AE 231



CANOVA

Linee e forme che rievocano le seducenti atmosfere degli anni '30.
Un must per chi ama la tradizione, la serie fa dell'attenzione ai dettagli e della ricercatezza nello stile i punti di forza di un rubinetto dalla vocazione nobile e aristocratica.

_Lines and shapes that evoke the seductive atmosphere of the '30s.
A must for those who love tradition, the series makes of attention to detail and refined style the strengths of a tap with a noble and aristocratic calling.



CN 103 92



CN 100

IMPERO

IMPERO è in grado di soddisfare completamente la nostalgica necessità di arredare il bagno in modo classico, senza rinunciare al piacere del design. È l'espressione del passato rivisitato e trasportato nel XXI secolo.

_IMPERO satisfies the nostalgic need to outfit the bathroom in a traditional style, without sacrificing the pleasure of design. It is the expression of the past revisited and transported to the twenty-first century.



IM 111 13



LONDRA

LONDRA si esprime nella gradevolezza dell'aspetto attraverso un sapiente gioco di forme e volumi, dettagli ricercati e accostamento di materiali, che ne fanno una serie che richiama l'armonia del passato riproposta in chiave attuale. L'eleganza è il massimo della sua espressione e, per chi ama il classico, Londra sarà la sola e unica scelta.

_LONDRA boasts an elegant look, thanks to a clever interplay of shapes, balanced volumes, refined details and a combination of materials. The series draws from the harmony of the past and reinvents it with modern accents. Epitomizing the ultimate elegance, Londra is the only possible choice for those who love classic style.

LD 102



WC JET



WJ 677



ART the range

CRISTINA

LAVABO - BIDET
_WASHBASIN - BIDET

VASCA - DOCCIA
_BATH - SHOWER



AR 211

Miscelatore monocomando REGULAR per lavabo con scarico da 1"1/4 e asta comando

_Basin mixer REGULAR with 1"1/4 pop up waste



AR 231

Set completo per miscelatore monocomando lavabo REGULAR da incasso con scarico Up&Down da 1"1/4

_Complete wall mounted basin mixer REGULAR with 1"1/4 Up&Down waste



AR 311

Miscelatore monocomando per bidet con scarico da 1"1/4 e asta comando

_Bidet mixer with 1"1/4 pop up waste



AR 401

Miscelatore monocomando per doccia esterno

_External shower mixer

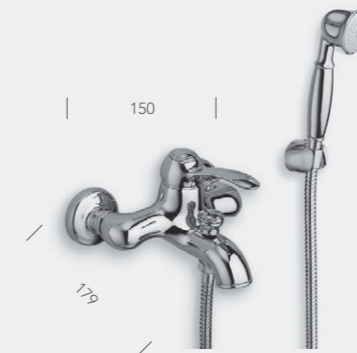

AR 100

Miscelatore monocomando per vasca esterno con flessibile e doccetta anticalcare

_External bath mixer with flexible hose and anti-lime hand shower



AR 107

Miscelatore monocomando per vasca esterno

_External bath mixer



AR 118

Set completo per miscelatore monocomando doccia da incasso con piastra in metallo

_Complete concealed shower mixer with metal plate



AR 686

Set da esterno per miscelatore monocomando doccia/vasca CS 535 con piastra in metallo

_Shower mixer external parts for CS 535 with metal plate



AR 689

Set da esterno per miscelatore monocomando doccia/vasca CS 535 con deviatore 2 uscite e piastra in metallo

_Bath/shower mixer external parts for CS 535 with 2 outlet diverter and metal plate

* interasse corpo - bocca

ART ELITE the range

CRISTINA

LAVABO - BIDET
_WASHBASIN - BIDET



AE 211

Miscelatore monocomando REGULAR per lavabo con scarico da 1"1/4 e asta comando

_Basin mixer REGULAR with 1"1/4 pop up waste



AE 311

Miscelatore monocomando per bidet con scarico da 1"1/4 e asta comando

_Bidet mixer with 1"1/4 pop up waste



AE 231

Set completo per miscelatore monocomando lavabo REGULAR da incasso con scarico Up&Down da 1"1/4

_Complete wall mounted basin mixer REGULAR with 1"1/4 Up&Down waste

VASCA - DOCCIA
_BATH - SHOWER



AE 401

Miscelatore monocomando per doccia esterno

_External shower mixer



AE 100

Miscelatore monocomando per vasca esterno con flessibile e doccetta anticalcare

_External bath mixer with flexible hose and anti-lime hand shower



AE 107

Miscelatore monocomando per vasca esterno

_External bath mixer

VASCA - DOCCIA
_BATH - SHOWER



AE 409

Miscelatore monocomando per doccia esterno con colonna girevole, soffione anticalcare ispezionabile, flessibile e doccetta anticalcare con supporto scorrevole

_External shower mixer with swivel column pipe, checkable anti-lime overhead shower, flexible hose anti-lime hand shower with slide rail



AE 118

Set completo per miscelatore monocomando doccia da incasso con piastra in metallo

_Complete concealed shower mixer with metal plate



AE 686

Set da esterno per miscelatore monocomando doccia/vasca CS 535 con piastra in metallo

_Shower mixer external parts for CS 535 with metal plate



AE 689

Set da esterno per miscelatore monocomando doccia/vasca CS 535 con deviatore 2 uscite e piastra in metallo

_Bath/shower mixer external parts for CS 535 with 2 outlet diverter and metal plate

* interasse corpo - bocca

CANOVA the range

CRISTINA

LAVABO - BIDET
_WASHBASIN - BIDET



CN 201

Miscelatore bicomando REGULAR per lavabo 3 fori con scarico da 1"1/4 e asta comando

_3 hole basin mixer REGULAR with 1"1/4 pop up waste



CN 202

Miscelatore bicomando LARGE per lavabo 3 fori con scarico da 1"1/4 e asta comando

_3 hole basin mixer LARGE with 1"1/4 pop up waste



CN 207

Miscelatore bicomando REGULAR per lavabo 3 fori con scarico da 1"1/4 e asta comando

_3 hole basin mixer REGULAR with 1"1/4 pop up waste



CN 230

Rubinetto "acqua fredda" da 1/2"

_1/2" "cold water" tap



CN 242

Set da esterno miscelatore bicomando lavabo REGULAR per CS 233 (comandi laterali) - CS 234 (comando destro) con scarico Up&Down da 1"1/4

_Wall mounted basin mixer REGULAR external parts for CS 233 (side controls) - CS 234 (right side) with 1"1/4 Up&Down waste



CN 301

Miscelatore bicomando per bidet 3 fori con scarico da 1"1/4 e asta comando

_3 hole bidet mixer with 1"1/4 pop up waste



CN 211

Miscelatore bicomando REGULAR per lavabo con scarico da 1"1/4 e asta comando

_Basin mixer REGULAR with 1"1/4 pop up waste



CN 212

Miscelatore bicomando LARGE per lavabo con scarico da 1"1/4 e asta comando

_Basin mixer LARGE with 1"1/4 pop up waste



CN 217

Miscelatore bicomando REGULAR per lavabo con scarico da 1"1/4 e asta comando

_Basin mixer REGULAR with 1"1/4 pop up waste



CN 307

Miscelatore bicomando per bidet 3 fori con scarico da 1"1/4 e asta comando

_3 hole bidet mixer with 1"1/4 pop up waste

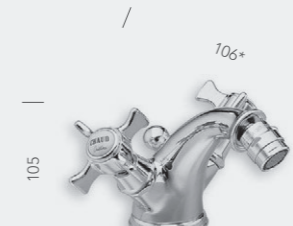

CN 311

Miscelatore bicomando per bidet con scarico da 1"1/4 e asta comando

_Bidet mixer with 1"1/4 pop up waste



CN 331

Miscelatore bicomando per bidet 3 fori con scarico da 1"1/4 e asta comando

_3 hole bidet mixer with 1"1/4 pop up waste

* interasse corpo - bocca

CANOVA the range

CRISTINA

VASCA - DOCCIA
_BATH - SHOWER



CN 412

Miscelatore bicomando per vasca/lavatoio esterno

_External bath/washtub mixer

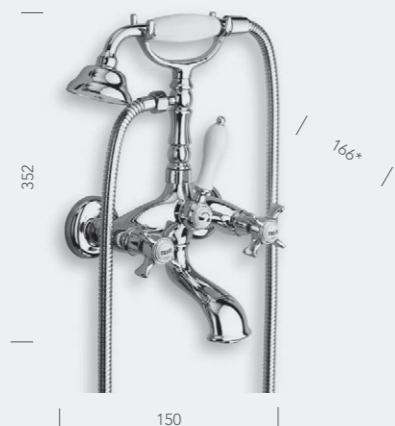

CN 100

Miscelatore bicomando per vasca esterno con flessibile e doccetta anticalcare

_External bath mixer with flexible hose and anti-lime hand shower



TR 100 CN

Miscelatore termostatico per vasca esterno con flessibile e doccetta anticalcare

_External thermostatic bath mixer with flexible hose and anti-lime hand shower



CN 114 | CN 115

Set completo per miscelatore bicomando doccia/vasca da incasso con deviatore 2/3 uscite

_Complete 3 hole concealed bath/shower mixer with 2/3 outlets diverter



CN 124

Miscelatore bicomando per bordo vasca 4 fori con bocca erogazione, doccetta anticalcare estraibile e deviatore

_4 hole deck mounted bath mixer with diverter, spout and pull-out anti-lime hand shower



CN 122

Miscelatore bicomando per bordo vasca 4 fori con doccetta anticalcare estraibile e deviatore 2 uscite

_4 hole deck mounted bath mixer with pull-out anti-lime hand shower and 2 outlets diverter

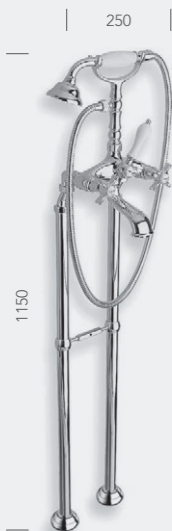

CN 102

Miscelatore bicomando per vasca esterno con colonne a pavimento, flessibile e doccetta anticalcare

_Floor mounted bath mixer with flexible hose and anti-lime hand shower



CN 103

Miscelatore bicomando per vasca esterno con colonne a pavimento, soffione anticalcare ispezionabile, flessibile e doccetta anticalcare con supporto scorrevole

_Floor mounted bath mixer with checkable anti-lime overhead shower, flexible hose and anti-lime hand shower with slide rail



TR 104 CN

Miscelatore termostatico per vasca esterno con soffione anticalcare ispezionabile, flessibile e doccetta anticalcare con supporto scorrevole

_External thermostatic bath mixer with checkable anti-lime overhead shower, flexible hose and anti-lime hand shower with slide rail

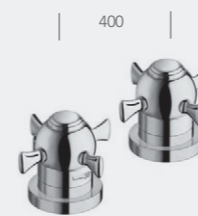

XC 142

Miscelatore termostatico per bordo vasca con deviatore 2 uscite

_Deck mounted thermostatic bath mixer with 2 outlets diverter



CN 182

Miscelatore termostatico per vasca esterno con flessibile e doccetta anticalcare

_External thermostatic bath mixer with flexible hose and anti-lime hand shower

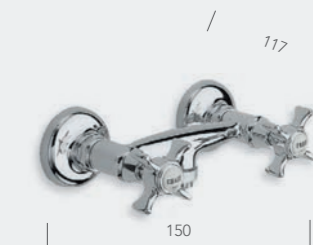

CN 401

Miscelatore bicomando per doccia esterno

_External shower mixer

* interasse corpo - bocca

CANOVA the range

CRISTINA

VASCA - DOCCIA
_BATH - SHOWER

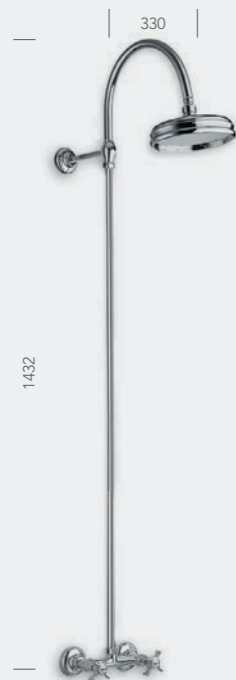

CN 407

Miscelatore bicomando per doccia esterno con soffione anticalcare ispezionabile

_External shower mixer with checkable anti-lime overhead shower



CN 409

Miscelatore bicomando per doccia esterno con soffione anticalcare ispezionabile, flessibile e doccetta anticalcare con supporto scorrevole

_External shower mixer with checkable anti-lime overhead shower, flexible hose and anti-lime hand shower with slide rail



TR 411 CN

Miscelatore termostatico per doccia esterno con soffione anticalcare ispezionabile, flessibile e doccetta anticalcare con supporto scorrevole

_External thermostatic shower mixer with checkable anti-lime overhead shower, flexible hose and anti-lime hand shower with slide rail



CN 666

Set da esterno per miscelatore monocomando progressivo doccia CS 535 con piastra in metallo

_Progressive shower mixer external parts for CS 535 with metal plate



CN 669

Set da esterno per miscelatore monocomando progressivo doccia/vasca CS 535 con deviatore 2 uscite e piastra in metallo

_Progressive bath/shower mixer external parts for CS 535 with 2 outlet diverter and metal plate



CN 620

Rubinetto d'arresto da 1/2"

_1/2" stopcock

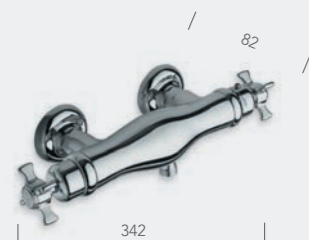

CN 481

Miscelatore termostatico per doccia esterno

_External thermostatic shower mixer



CN 486

Miscelatore termostatico per doccia esterno con soffione anticalcare ispezionabile, flessibile e doccetta anticalcare con supporto scorrevole

_External thermostatic shower mixer with checkable anti-lime overhead shower, flexible hose and anti-lime hand shower with slide rail



CN 621

Rubinetto d'arresto da 3/4"

_3/4" stopcock

* interasse corpo - bocca

CANOVA ELITE the range

CRISTINA

LAVABO - BIDET
_WASHBASIN - BIDET

VASCA - DOCCIA
_BATH - SHOWER



CL 201

Miscelatore bicomando REGULAR per lavabo 3 fori con scarico da 1"1/4 e asta comando

_3 hole basin mixer REGULAR with 1"1/4 pop up waste



CL 207

Miscelatore bicomando REGULAR per lavabo 3 fori con scarico da 1"1/4 e asta comando

_3 hole basin mixer REGULAR with 1"1/4 pop up waste



CL 242

Set da esterno miscelatore bicomando lavabo REGULAR per CS 233 (comandi laterali) - CS 234 (comando destro) con scarico Up&Down da 1"1/4

_Wall mounted basin mixer REGULAR external parts for CS 233 (side controls) - CS 234 (right side) with 1"1/4 Up&Down waste

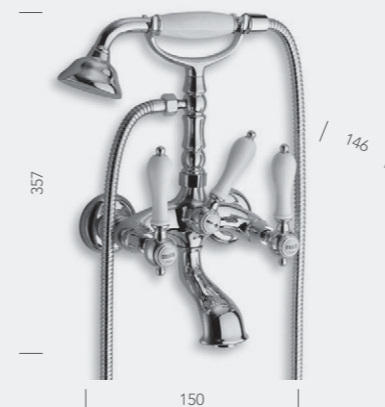

CL 100

Miscelatore bicomando per vasca esterno con flessibile e doccia anticalcare

_External bath mixer with flexible hose and anti-lime hand shower



CL 114 | CL 115

Set completo per miscelatore bicomando doccia/vasca da incasso con deviatore 2/3 uscite

_Complete 3 hole concealed bath/shower mixer with 2/3 outlets diverter



CL 124

Miscelatore bicomando per bordo vasca 4 fori con bocca erogazione, doccia anticalcare estraibile e deviatore

_4 hole deck mounted bath mixer with diverter, spout and pull-out anti-lime hand shower



CL 301

Miscelatore bicomando per bidet 3 fori con scarico da 1"1/4 e asta comando

_3 hole bidet mixer with 1"1/4 pop up waste



CL 307

Miscelatore bicomando per bidet 3 fori con scarico da 1"1/4 e asta comando

_Basin mixer LARGE with 1"1/4 pop up waste



CL 331

Miscelatore bicomando per bidet 3 fori con scarico da 1"1/4 e asta comando

_3 hole bidet mixer with 1"1/4 pop up waste



CL 620

Rubinetto d'arresto da 1/2"

_1/2" stopcock



CL 621

Rubinetto d'arresto da 3/4"

_3/4" stopcock

* interasse corpo - bocca

IMPERO the range

CRISTINA

LAVABO - BIDET
_WASHBASIN - BIDET



IM 201

Miscelatore bicomando REGULAR per lavabo 3 fori con scarico da 1"1/4 e asta comando

_3 hole basin mixer REGULAR with 1"1/4 pop up waste



IM 206

Miscelatore bicomando REGULAR per lavabo 3 fori con scarico da 1"1/4 e asta comando

_3 hole basin mixer REGULAR with 1"1/4 pop up waste



IM 211

Miscelatore bicomando REGULAR per lavabo con scarico da 1"1/4 e asta comando

_Basin mixer REGULAR with 1"1/4 pop up waste



IM 301

Miscelatore bicomando per bidet 3 fori con scarico da 1"1/4 e asta comando

_3 hole bidet mixer with 1"1/4 pop up waste

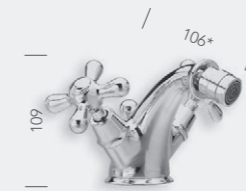

IM 311

Miscelatore bicomando per bidet con scarico da 1"1/4 e asta comando

_Bidet mixer with 1"1/4 pop up waste



IM 331

Miscelatore bicomando per bidet 3 fori con scarico da 1"1/4 e asta comando

_3 hole bidet mixer with 1"1/4 pop up waste



IM 217

Miscelatore bicomando REGULAR per lavabo con scarico da 1"1/4 e asta comando

_Basin mixer REGULAR with 1"1/4 pop up waste



IM 230

Rubinetto "acqua fredda" da 1/2"

_1/2" "cold water" tap



IM 245

Rubinetto "acqua fredda" da 1/2"

_1/2" "cold water" tap



IM 401

Miscelatore bicomando per doccia esterno

_External shower mixer



IM 481

Miscelatore termostatico per doccia esterno

_External thermostatic shower mixer



IM 486

Miscelatore termostatico per doccia esterno con soffione anticalcare ispezionabile, flessibile e doccetta anticalcare con supporto scorrevole

_External thermostatic shower mixer with checkable anti-lime overhead shower, flexible hose and anti-lime hand shower with slide rail

* interasse corpo - bocca

IMPERO the range

CRISTINA

LAVABO - BIDET
_WASHBASIN - BIDET

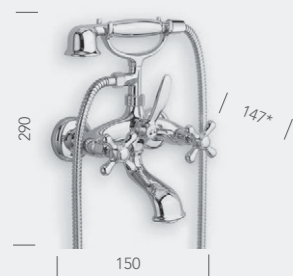

IM 100

Miscelatore bicomando per vasca esterno con flessibile e doccetta anticalcare

_External bath mixer with flexible hose and anti-lime hand shower



IM 412

Miscelatore bicomando per vasca/lavatoio esterno

_External bath/washtub mixer

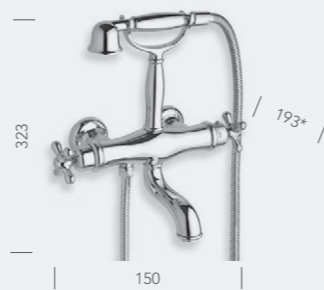

IM 182

Miscelatore termostatico per vasca esterno con flessibile e doccetta anticalcare

_External thermostatic bath mixer with flexible hose and anti-lime hand shower



IM 666

Set da esterno per miscelatore monocomando progressivo doccia CS 535 con piastra in metallo

_ Progressive shower mixer external parts for CS 535 with metal plate



IM 669

Set da esterno per miscelatore monocomando progressivo doccia/vasca CS 535 con deviatore 2 uscite e piastra in metallo

_ Progressive bath/shower mixer external parts for CS 535 with 2 outlet diverter and metal plate



IM 646

Rubinetto singolo per lavatrice a incasso da 1/2"

_1/2" wall mounted tap for washing machine



IM 114 | IM 115

Set completo per miscelatore bicomando doccia/vasca da incasso con deviatore 2/3 uscite

_Complete 3 hole concealed bath/shower mixer with 2/3 outlets diverter



IM 124

Miscelatore bicomando per bordo vasca 4 fori con bocca erogazione, doccetta anticalcare estraibile e deviatore

_4 hole deck mounted bath mixer with diverter, spout and pull-out anti-lime hand showers



IM 122

Miscelatore bicomando per bordo vasca 4 fori con doccetta anticalcare estraibile e deviatore 2 uscite

_4 hole deck mounted bath mixer with pull-out anti-lime hand shower and 2 outlets diverter



IM 652

Rubinetto "acqua fredda" a incasso da 1/2"

_1/2" wall mounted "cold water" tap

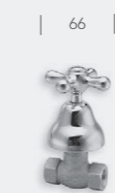

IM 620

Rubinetto d'arresto da 1/2"

_1/2" stopcock



IM 621

Rubinetto d'arresto da 3/4"

_3/4" stopcock

* interasse corpo - bocca

LONDRA the range

CRISTINA

LAVABO - BIDET
_WASHBASIN - BIDET



LD 201

Miscelatore bicomando REGULAR per lavabo 3 fori con scaricoda 1"1/4 e asta comando

_3 hole basin mixer REGULAR with 1"1/4 pop up waste



LD 203

Miscelatore bicomando REGULAR per lavabo 3 fori con scaricoda 1"1/4 e asta comando

_3 hole basin mixer REGULAR with 1"1/4 pop up waste



LD 207

Miscelatore bicomando REGULAR per lavabo 3 fori con scaricoda 1"1/4 e asta comando

_3 hole basin mixer REGULAR with 1"1/4 pop up waste



LD 301

Miscelatore bicomando per bidet 3 fori con scarico da 1"1/4 e asta comando

_3 hole bidet mixer with 1"1/4 pop up waste



LD 307

Miscelatore bicomando per bidet 3 fori con scarico da 1"1/4 e asta comando

_3 hole bidet mixer with 1"1/4 pop up waste



LD 321

Miscelatore bicomando per bidet con scarico da 1"1/4 e asta comando

_Bidet mixer with 1"1/4 pop up waste



LD 221

Miscelatore bicomando REGULAR per lavabo con scarico da 1"1/4 e asta comando

_Basin mixer REGULAR with 1"1/4 pop up waste



LD 230

Rubinetto "acqua fredda" da 1/2"

_1/2" "cold water" tap



LD 242

Set da esterno miscelatore bicomando lavabo REGULAR per CS 233 (comandi laterali) - CS 234 (comando destro) con scarico Up&Down da 1"1/4

_Wall mounted basin mixer REGULAR external parts for CS 233 (side controls) - CS 234 (right side) with 1"1/4 Up&Down waste



LD 331

Miscelatore bicomando per bidet 3 fori con scarico da 1"1/4 e asta comando

_3 hole bidet mixer with 1"1/4 pop up waste

* interasse corpo - bocca

LONDRA the range

CRISTINA

VASCA - DOCCIA
_BATH - SHOWER



LD 412

Miscelatore bicomando per vasca/lavatoio esterno

_External bath/washtub mixer



LD 100

Miscelatore bicomando per vasca esterno con flessibile e doccetta anticalcare

_External bath mixer with flexible hose and anti-lime hand shower



LD 182

Miscelatore termostatico per vasca esterno con flessibile e doccetta anticalcare

_External thermostatic bath mixer with flexible hose and anti-lime hand shower



LD 124

Miscelatore bicomando per bordo vasca 4 fori con bocca erogazione, doccetta anticalcare estraibile e deviatore

_4 hole deck mounted bath mixer with diverter, spout and pull-out anti-lime hand shower



LD 122

Miscelatore bicomando per bordo vasca 4 fori con doccetta anticalcare estraibile e deviatore 2 uscite

_4 hole deck mounted bath mixer with pull-out anti-lime hand shower and 2 outlets diverter



LD 401

Miscelatore bicomando per doccia esterno

_ External shower mixer

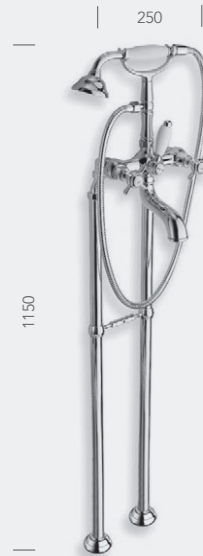

LD 102

Miscelatore bicomando per vasca esterno con colonne a pavimento, flessibile e doccetta anticalcare

_Floor mounted bath mixer with flexible hose and anti-lime hand shower



LD 103

Miscelatore bicomando per vasca esterno con colonne a pavimento, soffione anticalcare ispezionabile, flessibile e doccetta anticalcare con supporto scorrevole

_Floor mounted bath mixer with checkable anti-lime overhead shower, flexible hose and anti-lime hand shower with slide rail



LD 114 | LD 115

Set completo per miscelatore bicomando doccia/vasca da incasso con deviatore 2/3 uscite

_Complete 3 hole concealed bath/shower mixer with 2/3 outlets diverter



LD 481

Miscelatore termostatico per doccia esterno

_External thermostatic shower mixer



LD 409

Miscelatore bicomando per doccia esterno con soffione anticalcare ispezionabile, flessibile e doccetta anticalcare con supporto scorrevole

_External shower mixer with checkable anti-lime overhead shower, flexible hose and anti-lime hand shower with slide rail



LD 486

Miscelatore termostatico per doccia esterno con soffione anticalcare ispezionabile, flessibile e doccetta anticalcare con supporto scorrevole

_External thermostatic shower mixer with checkable anti-lime overhead shower, flexible hose and anti-lime hand shower with slide rail

* interasse corpo - bocca

LONDRA the range

CRISTINA

VASCA - DOCCIA
_BATH - SHOWER



LD 666

Set da esterno per miscelatore monocomando progressivo doccia CS 535 con piastra in metallo

_ Progressive shower mixer external parts for CS 535 with metal plate



LD 669

Set da esterno per miscelatore monocomando progressivo doccia/vasca CS 535 con deviatore 2 uscite e piastra in metallo

_ Progressive bath/shower mixer external parts for CS 535 with 2 outlet diverter and metal plate



LD 620

Rubinetto d'arresto da 1/2"

_ 1/2" stopcock



LD 621

Rubinetto d'arresto da 3/4"

_ 3/4" stopcock

* interasse corpo - bocca



WJ 677

Miscelatore monocomando per wc/bidet esterno con flessibile e doccetta con chiusura

_WC/bidet mixer valve with integrated douche handset holder and flexible hose



WJ 674

Miscelatore monocomando progressivo per wc/bidet esterno con flessibile e doccetta con chiusura

_WC/bidet progressive mixer valve with integrated douche handset holder and flexible hose



WJ 662

Set completo per miscelatore monocomando wc/bidet da incasso con flessibile, piastra in metallo e doccetta orientabile con chiusura

_WC/bidet mixer valve with douche handset, metal plate and wall mounted adjustable bracket with flexible hose

FINISHINGS



ART			●		●
ART ELITE					●
CANOVA			●	●	●
IMPERO	●	●	●		●
LONDRA					●



ART			●	●
ART ELITE				●
CANOVA	●		●	●
IMPERO	●	●	●	●
LONDRA	●			●

SHOWERHEADS AND WATERFALL

Una collezione di soffioni e bocche erogazione con getto a cascata pensata per trasformare il rito della doccia in un momento speciale. Il design rigoroso e pulito di questi prodotti si abbina perfettamente a qualsiasi stile d'arredo ed esalta la forma variabile dell'acqua che diventa indiscussa protagonista. Alcuni modelli sono disponibili con l'illuminazione e tra questi c'è DYNAMO SHOWER, un prodotto dedicato al benessere e al relax dal "cuore" sostenibile. È assolutamente ecologico in quanto non consuma energia elettrica: il flusso d'acqua, passando per una turbina collocata all'interno del soffione, crea e fornisce energia sufficiente per l'accensione dei led.

_A collection of shower heads and cascade spouts designed to transform the shower ritual in a special moment. The rigorous and fine design of these products matches perfectly any style of furniture and enhances the variable shape of the water that becomes the chief protagonist. Some models are available with lighting like the DYNAMO SHOWER a product dedicated to wellness and relaxation built around a green heart. The fully selfpowered showerhead with led lighting it is completely environmentally friendly because it does not consume electricity. The flow of water through a turbine placed inside of showerhead creates and provides enough power for lighting the LEDs.

PD 029 + PD 929



PD 027 + PD 411



PD 006 + PD 410





PD 380



PD 042



PD 381



PD 390



PD 368



PD 028 + PD 929



BD 321

INOX THERMOSTATIC EXTERNAL PARTS

I set da esterno a seguire possono essere disposti sia in verticale che in orizzontale

The following external parts can be installed either in a horizontal or vertical

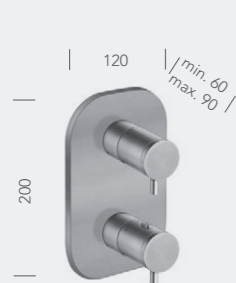
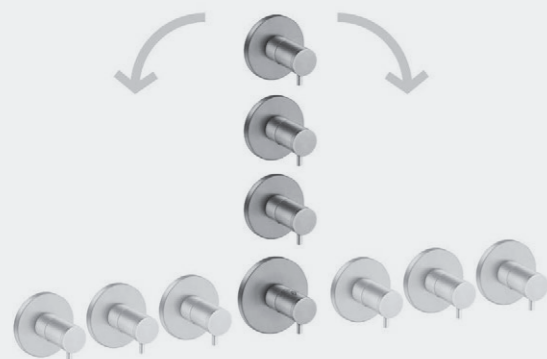

XX 751 | XX 752 | XX 753

Set da esterno per miscelatore termostatico doccia/vasca CS 800 con valvola d'arresto 1,2 e 3 uscite

Thermostatic shower/bath mixer external parts for CS 800 with 1, and 3 outlet shut-off valve

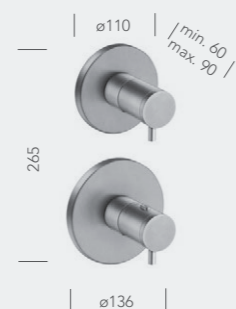

XX 771

Set da esterno per miscelatore termostatico CS 701

Thermostatic mixer external parts for CS 701

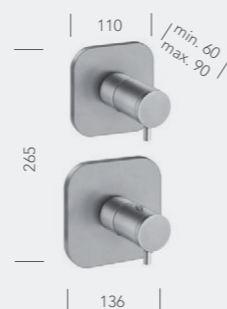

XX 671

Set da esterno per miscelatore termostatico CS 701

Thermostatic mixer external parts for CS 701

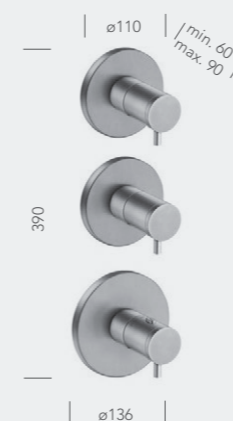

XX 772

Set da esterno per miscelatore termostatico CS 702

Thermostatic mixer external parts for CS 702

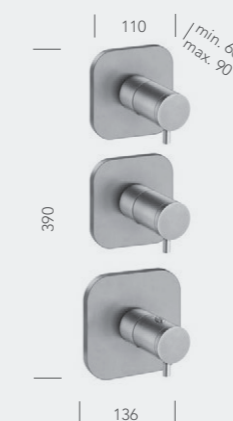

XX 672

Set da esterno per miscelatore termostatico CS 702

Thermostatic mixer external parts for CS 702

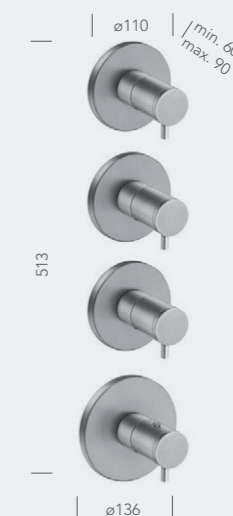

XX 773

Set da esterno per miscelatore termostatico CS 703

Thermostatic mixer external parts for CS 703

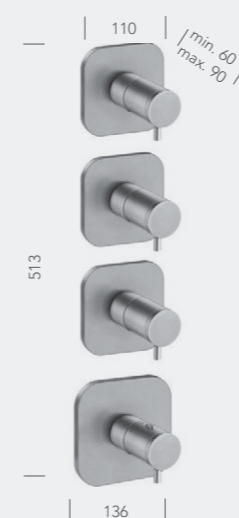

XX 673

Set da esterno per miscelatore termostatico CS 703

Thermostatic mixer external parts for CS 703

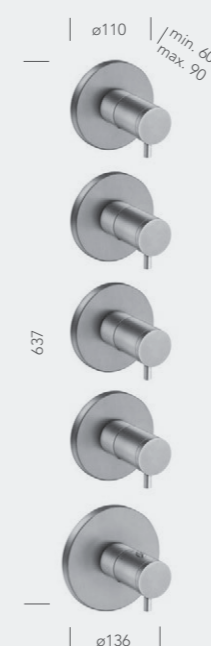

XX 774

Set da esterno per miscelatore termostatico CS 704

Thermostatic mixer external parts for CS 704

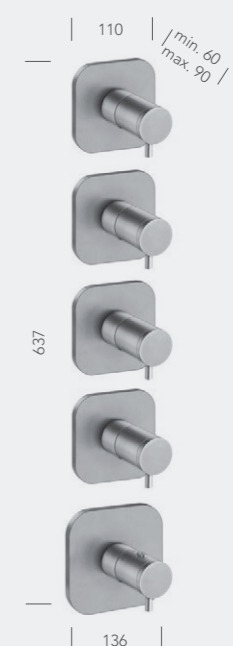

XX 674

Set da esterno per miscelatore termostatico CS 704

Thermostatic mixer external parts for CS 704

INOX THERMOSTATIC EXTERNAL PARTS



XX 700

Set da esterno per miscelatore termostatico CS 700

_Thermostatic mixer external parts for CS 700



XX 600

Set da esterno per miscelatore termostatico CS 700

_Thermostatic mixer external parts for CS 700



XX 710

Set da esterno per valvola d'arresto CS 710 - CS 750

_Shut-off tap external parts for CS 710 - CS 750



XX 620

Set da esterno per valvola d'arresto CS 770

_Shut-off tap external parts for CS 770



XX 833

Set da esterno per soffione anticalcare body-jet CS 705 - CS 706 - CS 707

_Anti-lime body jet external parts for CS 705 - CS 706 - CS 707



XX 633

Set da esterno per soffione anticalcare body-jet CS 705 - CS 706 - CS 707

_Anti-lime body jet external parts for CS 705 - CS 706 - CS 707



XX 610

Set da esterno per valvola d'arresto CS 710 - CS 750

_Shut-off tap external parts for CS 710 - CS 750



XX 720

Set da esterno per valvola d'arresto CS 770

_Shut-off tap external parts for CS 770

THERMOSTATIC EXTERNAL PARTS

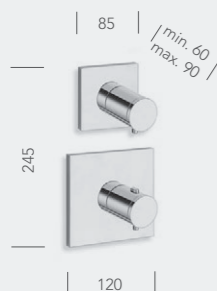

XT 771

Set da esterno per miscelatore termostatico CS 701 con piastra in metallo

_Thermostatic mixer external parts for CS 701 with metal plate

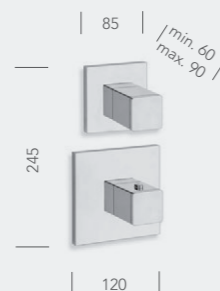

XQ 771

Set da esterno per miscelatore termostatico CS 701 con piastra in metallo

_Thermostatic mixer external parts for CS 701 with metal plate

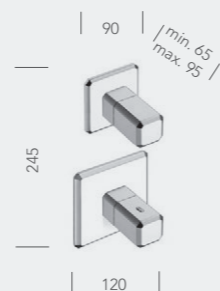

IT 771

Set da esterno per miscelatore termostatico CS 701 con piastra in metallo

_Thermostatic mixer external parts for CS 701 with metal plate

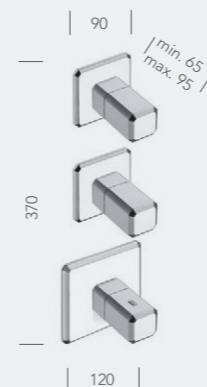

IT 772

Set da esterno per miscelatore termostatico CS 702 con piastra in metallo

_Thermostatic mixer external parts for CS 702 with metal plate

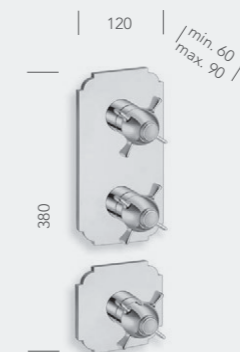

XC 782

Set da esterno per miscelatore termostatico CS 702 con piastra in metallo

_Thermostatic mixer external parts for CS 702 with metal plate

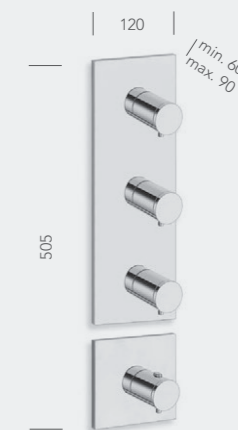

XT 783

Set da esterno per miscelatore termostatico CS 703 con piastra in metallo

_Thermostatic mixer external parts for CS 703 with metal plate

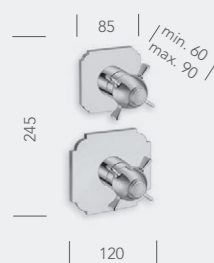

XC 771

Set da esterno per miscelatore termostatico CS 701 con piastra in metallo

_Thermostatic mixer external parts for CS 701 with metal plate

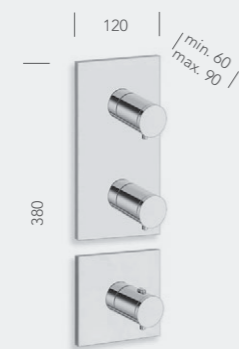

XT 782

Set da esterno per miscelatore termostatico CS 702 con piastra in metallo

_Thermostatic mixer external parts for CS 702 with metal plate

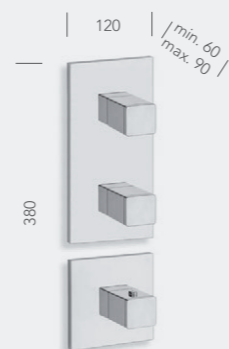

XQ 782

Set da esterno per miscelatore termostatico CS 702 con piastra in metallo

_Thermostatic mixer external parts for CS 702 with metal plate

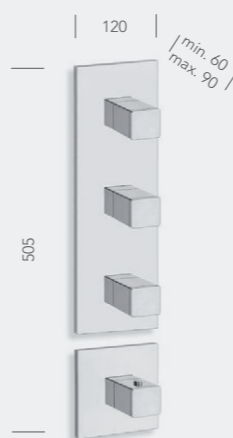

XQ 783

Set da esterno per miscelatore termostatico CS 703 con piastra in metallo

_Thermostatic mixer external parts for CS 703 with metal plate

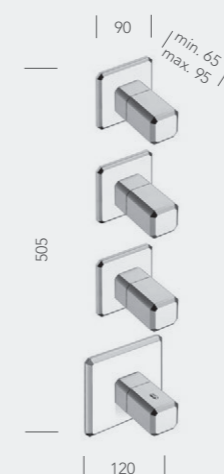

IT 773

Set da esterno per miscelatore termostatico CS 703 con piastra in metallo

_Thermostatic mixer external parts for CS 703 with metal plate

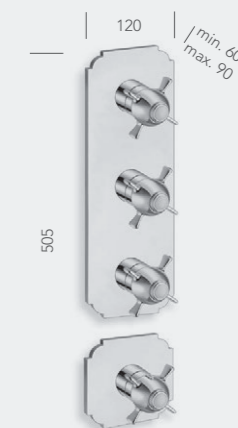

XC 783

Set da esterno per miscelatore termostatico CS 703 con piastra in metallo

_Thermostatic mixer external parts for CS 703 with metal plate

THERMOSTATIC EXTERNAL PARTS

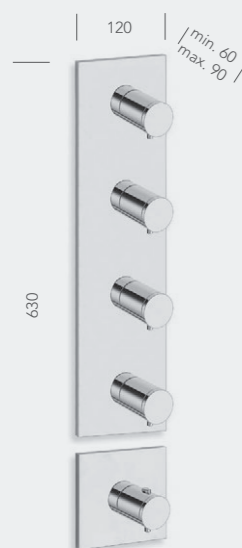

XT 784

Set da esterno per miscelatore termostatico CS 704 con piastra in metallo

_Thermostatic mixer external parts for CS 704 with metal plate

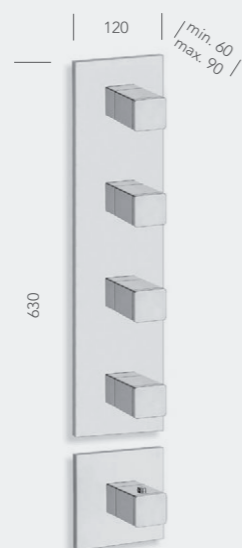

XQ 784

Set da esterno per miscelatore termostatico CS 704 con piastra in metallo

_Thermostatic mixer external parts for CS 704 with metal plate

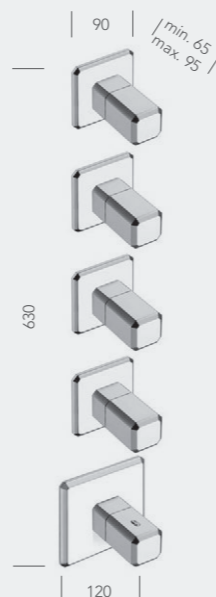

IT 774

Set da esterno per miscelatore termostatico CS 704 con piastra in metallo

_Thermostatic mixer external parts for CS 704 with metal plate

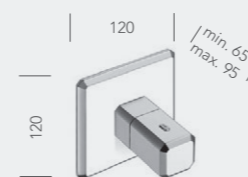

IT 700

Set da esterno per miscelatore termostatico CS 700 con piastra in metallo

_Thermostatic mixer external parts for CS 700 with metal plate



XC 700

Set da esterno per miscelatore termostatico CS 700 con piastra in metallo

_Thermostatic mixer external parts for CS 700 with metal plate



XT 710

Set da esterno per miscelatore termostatico CS 710 - CS 750 con piastra in metallo

_Thermostatic mixer external parts for CS 700 with metal plate

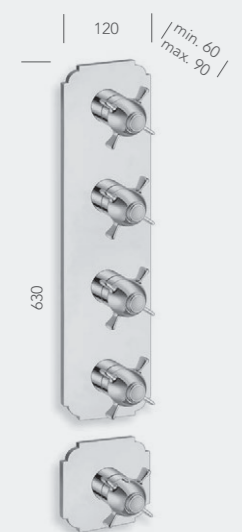

XC 784

Set da esterno per miscelatore termostatico CS 704 con piastra in metallo

_Thermostatic mixer external parts for CS 704 with metal plate



XT 700

Set da esterno per miscelatore termostatico CS 700 con piastra in metallo

_Thermostatic mixer external parts for CS 700 with metal plate

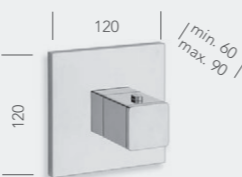

XQ 700

Set da esterno per miscelatore termostatico CS 700 con piastra in metallo

_Thermostatic mixer external parts for CS 700 with metal plate

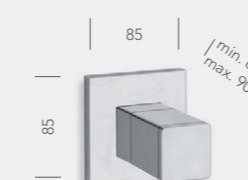

XQ 710

Set da esterno per miscelatore termostatico CS 700 con piastra in metallo

_Thermostatic mixer external parts for CS 700 with metal plate

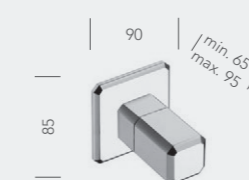

IT 710

Set da esterno per miscelatore termostatico CS 700 con piastra in metallo

_Thermostatic mixer external parts for CS 700 with metal plate

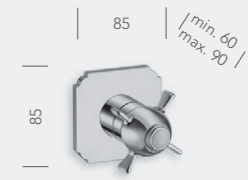

XC 710

Set da esterno per miscelatore termostatico CS 700 con piastra in metallo

_Thermostatic mixer external parts for CS 700 with metal plate

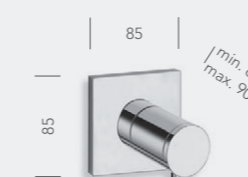

XT 720

Set da esterno per valvola d'arresto CS 770 con 2 uscite e piastra in metallo

_Shut-off tap external parts for CS 770 with 2 outlets and metal plate

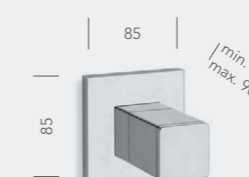

XQ 720

Set da esterno per valvola d'arresto CS 770 con 2 uscite e piastra in metallo

_Shut-off tap external parts for CS 770 with 2 outlets and metal plate

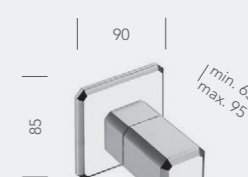

IT 720

Set da esterno per valvola d'arresto CS 770 con 2 uscite e piastra in metallo

_Shut-off tap external parts for CS 770 with 2 outlets and metal plate

THERMOSTATIC EXTERNAL PARTS

I comandi termostatici THERMO UP gestiscono l'uscita dell'acqua attraverso semplici pulsanti. Oltre all'apertura e alla chiusura dell'erogazione, i pulsanti ruotando regolano la portata dell'acqua. L'intera gamma THERMO UP offre la possibilità di combinare contemporaneamente le diverse uscite d'acqua.

The THERMO UP thermostatic dials allow to control the water by simply pressing the buttons. The push buttons do not only turn water on and off, but also control the flow when you turn them. The different outlet options can be combined and used simultaneously in all the products of the THERMO UP collection.

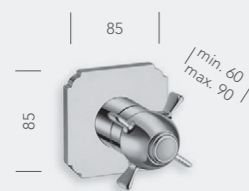

XC 720

Set da esterno per valvola d'arresto CS 770 con 2 uscite e piastra in metallo

_Shut-off tap external parts for CS 770 with 2 outlets and metal plate



XT 833

Set da esterno per soffione anticalcare body-jet CS 705 - CS 706 - CS 707 con piastra in metallo

_Anti-lime body jet external parts for CS 705 - CS 706 - CS 707

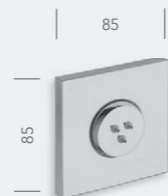

XQ 833

Set da esterno per soffione anticalcare body-jet CS 705 - CS 706 - CS 707 con piastra in metallo

_Anti-lime body jet external parts for CS 705 - CS 706 - CS 707



XT 712

Set da esterno per miscelatore termostatico CS 812 con piastra in metallo

_Thermostatic mixer external parts for CS 812 with metal plate



XQ 712

Set da esterno per miscelatore termostatico CS 812 con piastra in metallo

_Thermostatic mixer external parts for CS 812 with metal plate



XT 713

Set da esterno per miscelatore termostatico CS 813 con piastra in metallo

_Thermostatic mixer external parts for CS 813 with metal plate

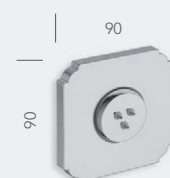

XC 833

Set da esterno per soffione anticalcare body-jet CS 705 - CS 706 - CS 707 con piastra in metallo

_Anti-lime body jet external parts for CS 705 - CS 706 - CS 707



XQ 713

Set da esterno per miscelatore termostatico CS 813 con piastra in metallo

_Thermostatic mixer external parts for CS 813 with metal plate

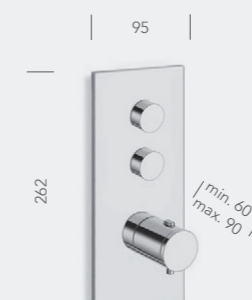

XT 722

Set da esterno per miscelatore termostatico CS 812 con piastra in metallo

_Thermostatic mixer external parts for CS 812 with metal plate

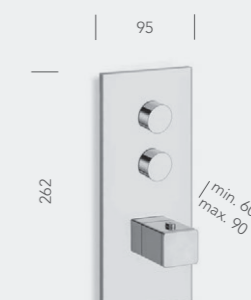

XQ 722

Set da esterno per miscelatore termostatico CS 812 con piastra in metallo

_Thermostatic mixer external parts for CS 812 with metal plate

THERMOSTATIC EXTERNAL PARTS



XT 723

Set da esterno per miscelatore termostatico CS 813 con piastra in metallo

_Thermostatic mixer external parts for CS 813 with metal plate

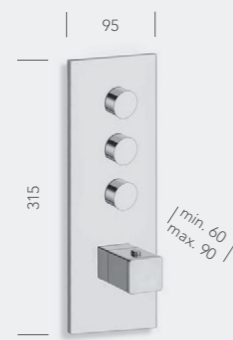

XQ 723

Set da esterno per miscelatore termostatico CS 813 con piastra in metallo

_Thermostatic mixer external parts for CS 813 with metal plate



XT 767

Set da esterno per miscelatore termostatico CS 718 con doccia anticalcare, flessibile LONG LIFE e piastra in metallo

_Thermostatic mixer external parts for CS 718 with anti-lime hand shower, LONG LIFE flexible hose and metal plate

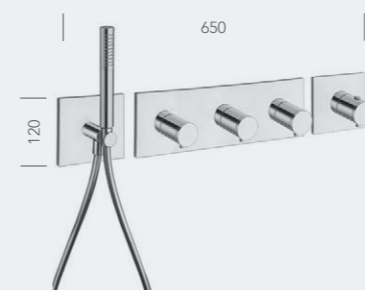

XT 769

Set da esterno per miscelatore termostatico CS 719 con doccia anticalcare, flessibile LONG LIFE e piastra in metallo

_Thermostatic mixer external parts for CS 718 with anti-lime hand shower, LONG LIFE flexible hose and metal plate

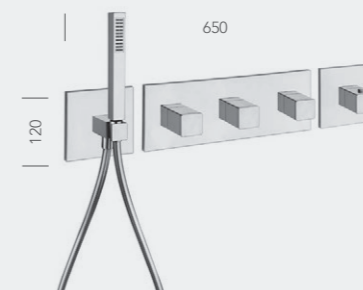

XQ 769

Set da esterno per miscelatore termostatico CS 719 con doccia anticalcare, flessibile LONG LIFE e piastra in metallo

_Thermostatic mixer external parts for CS 718 with anti-lime hand shower, LONG LIFE flexible hose and metal plate

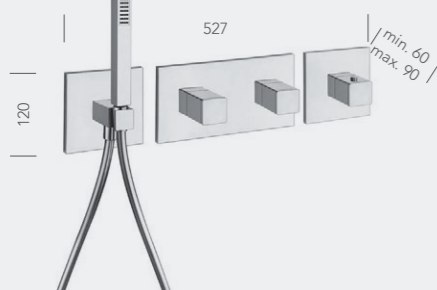

XQ 767

Set da esterno per miscelatore termostatico CS 718 con doccia anticalcare, flessibile LONG LIFE e piastra in metallo

_Thermostatic mixer external parts for CS 718 with anti-lime hand shower, LONG LIFE flexible hose and metal plate

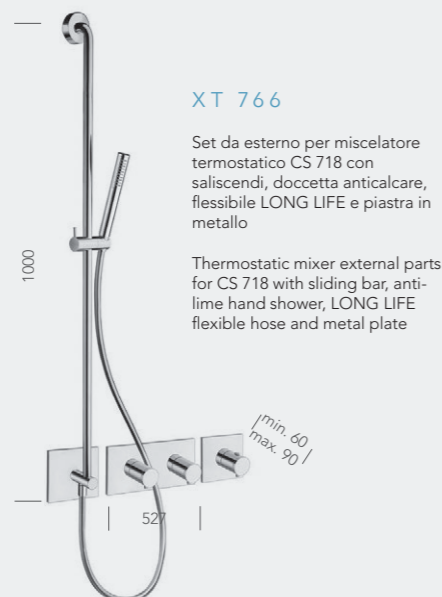

XT 766

Set da esterno per miscelatore termostatico CS 718 con saliscendi, doccia anticalcare, flessibile LONG LIFE e piastra in metallo

Thermostatic mixer external parts for CS 718 with sliding bar, anti-lime hand shower, LONG LIFE flexible hose and metal plate

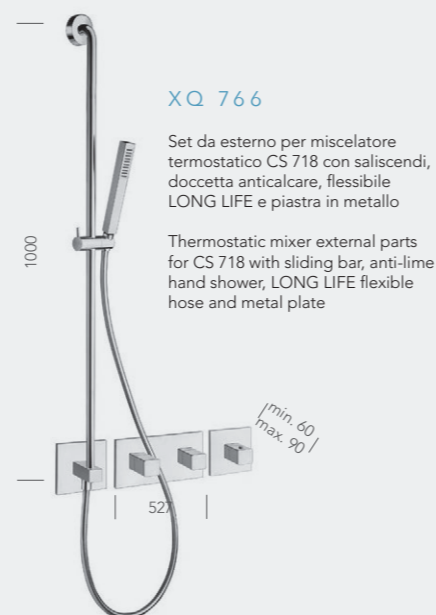

XQ 766

Set da esterno per miscelatore termostatico CS 718 con saliscendi, doccia anticalcare, flessibile LONG LIFE e piastra in metallo

Thermostatic mixer external parts for CS 718 with sliding bar, anti-lime hand shower, LONG LIFE flexible hose and metal plate

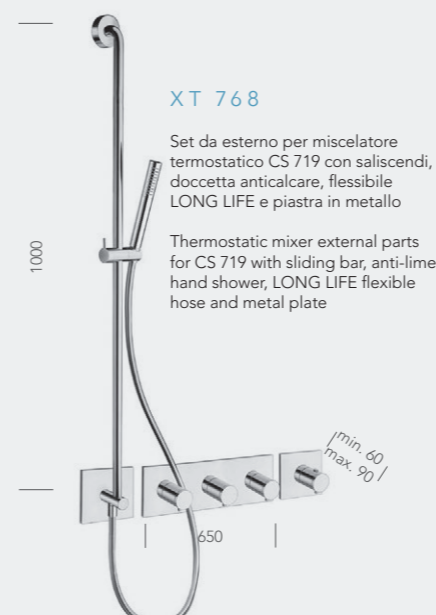

XT 768

Set da esterno per miscelatore termostatico CS 719 con saliscendi, doccia anticalcare, flessibile LONG LIFE e piastra in metallo

Thermostatic mixer external parts for CS 719 with sliding bar, anti-lime hand shower, LONG LIFE flexible hose and metal plate

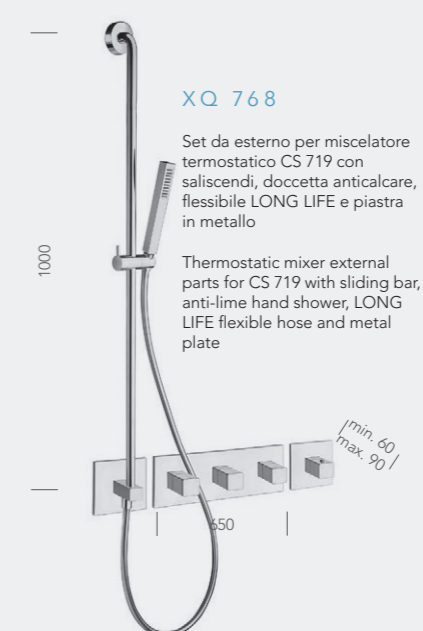

XQ 768

Set da esterno per miscelatore termostatico CS 719 con saliscendi, doccia anticalcare, flessibile LONG LIFE e piastra in metallo

Thermostatic mixer external parts for CS 719 with sliding bar, anti-lime hand shower, LONG LIFE flexible hose and metal plate

THERMOSTATIC EXTERNAL PARTS

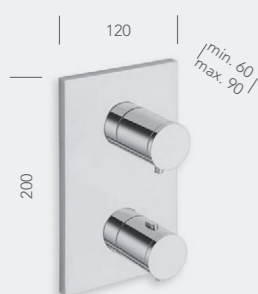

XT 751

Set da esterno per miscelatore termostatico doccia/vasca CS 800 con valvola d'arresto 1 uscita e piastra in metallo

_Thermostatic shower/bath mixer external parts for CS 800 with 1 outlet shut-off valve and metal plate

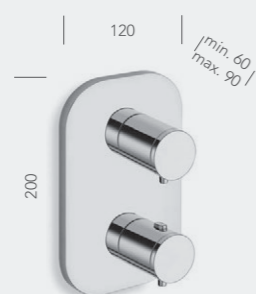

XT 651

Set da esterno per miscelatore termostatico doccia/vasca CS 800 con valvola d'arresto 1 uscita e piastra in metallo

_Thermostatic shower/bath mixer external parts for CS 800 with 1 outlet shut-off valve and metal plate



XV 751

Set da esterno per miscelatore termostatico doccia/vasca CS 800 con valvola d'arresto 1 uscita e piastra in metallo

_Thermostatic shower/bath mixer external parts for CS 800 with 1 outlet shut-off valve and metal plate

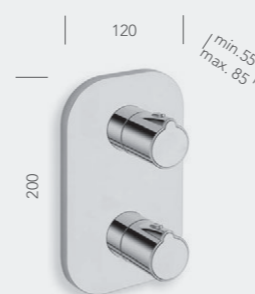

XE 751

Set da esterno per miscelatore termostatico doccia/vasca CS 800 con valvola d'arresto 1 uscita e piastra in ABS

_Thermostatic shower/bath mixer external parts for CS 800 with 1 outlet shut-off valve, ABS handles and plate

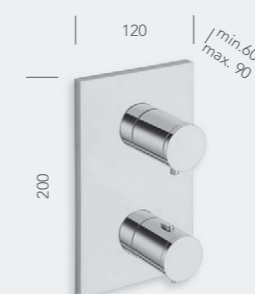

XT 752

Set da esterno per miscelatore termostatico doccia/vasca CS 800 con valvola d'arresto 2 uscite e piastra in metallo

_Thermostatic shower/bath mixer external parts for CS 800 with 2 outlet shut-off valve and metal plate

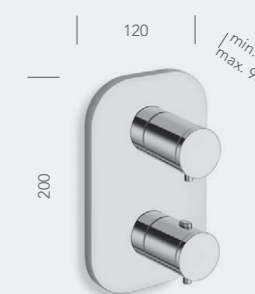

XT 652

Set da esterno per miscelatore termostatico doccia/vasca CS 800 con valvola d'arresto 2 uscite e piastra in metallo

_Thermostatic shower/bath mixer external parts for CS 800 with 2 outlet shut-off valve and metal plate

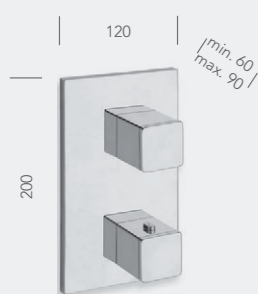

XQ 751

Set da esterno per miscelatore termostatico doccia/vasca CS 800 con valvola d'arresto 1 uscita e piastra in metallo

_Thermostatic shower/bath mixer external parts for CS 800 with 1 outlet shut-off valve and metal plate

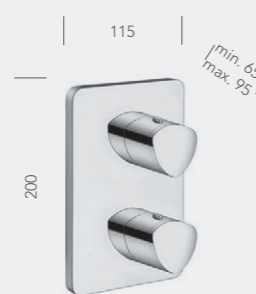

XF 751

Set da esterno per miscelatore termostatico doccia/vasca CS 800 con valvola d'arresto 1 uscita e piastra in metallo

_Thermostatic shower/bath mixer external parts for CS 800 with 1 outlet shut-off valve and metal plate



XC 751

Set da esterno per miscelatore termostatico doccia/vasca CS 800 con valvola d'arresto 1 uscita e piastra in metallo

_Thermostatic shower/bath mixer external parts for CS 800 with 1 outlet shut-off valve and metal plate



XV 752

Set da esterno per miscelatore termostatico doccia/vasca CS 800 con valvola d'arresto 2 uscite e piastra in metallo

_Thermostatic shower/bath mixer external parts for CS 800 with 2 outlet shut-off valve and metal plate

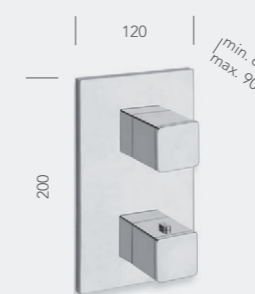

XQ 752

Set da esterno per miscelatore termostatico doccia/vasca CS 800 con valvola d'arresto 2 uscite e piastra in metallo

_Thermostatic shower/bath mixer external parts for CS 800 with 2 outlet shut-off valve and metal plate

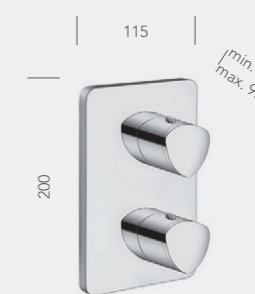

XF 752

Set da esterno per miscelatore termostatico doccia/vasca CS 800 con valvola d'arresto 2 uscite e piastra in metallo

_Thermostatic shower/bath mixer external parts for CS 800 with 2 outlet shut-off valve and metal plate

THERMOSTATIC EXTERNAL PARTS

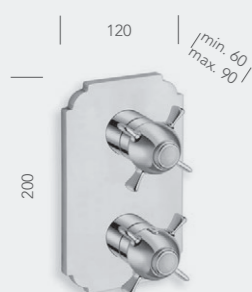

XC 752

Set da esterno per miscelatore termostatico doccia/vasca CS 800 con valvola d'arresto 2 uscite e piastra in metallo

_Thermostatic shower/bath mixer external parts for CS 800 with 2 outlet shut-off valve and metal plate

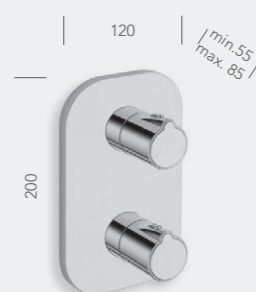

XE 752

Set da esterno per miscelatore termostatico doccia/vasca CS 800 con valvola d'arresto 2 uscite e piastra in ABS

_Thermostatic shower/bath mixer external parts for CS 800 with 2 outlet shut-off valve, ABS handles and plate

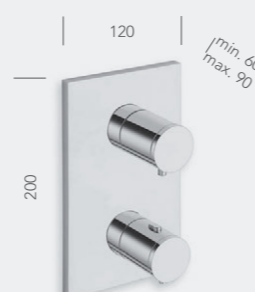

XT 753

Set da esterno per miscelatore termostatico doccia/vasca CS 800 con valvola d'arresto 3 uscite e piastra in metallo

_Thermostatic shower/bath mixer external parts for CS 800 with 3 outlet shut-off valve and metal plate

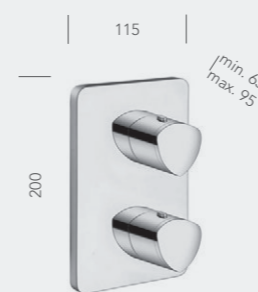

XF 753

Set da esterno per miscelatore termostatico doccia/vasca CS 800 con valvola d'arresto 3 uscite e piastra in metallo

_Thermostatic shower/bath mixer external parts for CS 800 with 3 outlet shut-off valve and metal plate

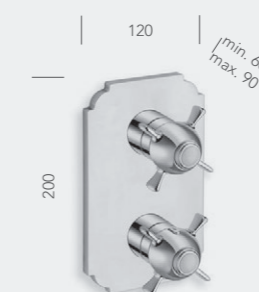

XC 753

Set da esterno per miscelatore termostatico doccia/vasca CS 800 con valvola d'arresto 3 uscite e piastra in metallo

_Thermostatic shower/bath mixer external parts for CS 800 with 3 outlet shut-off valve and metal plate

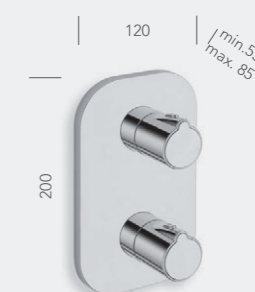

XE 753

Set da esterno per miscelatore termostatico doccia/vasca CS 800 con valvola d'arresto 3 uscite e piastra in ABS

_Thermostatic shower/bath mixer external parts for CS 800 with 3 outlet shut-off valve, ABS handles and plate

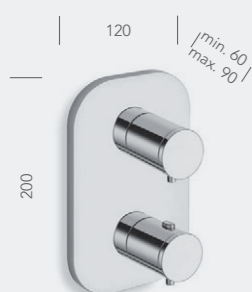

XT 653

Set da esterno per miscelatore termostatico doccia/vasca CS 800 con valvola d'arresto 3 uscite e piastra in metallo

_Thermostatic shower/bath mixer external parts for CS 800 with 3 outlet shut-off valve, and metal plate



XV 753

Set da esterno per miscelatore termostatico doccia/vasca CS 800 con valvola d'arresto 3 uscite e piastra in metallo

_Thermostatic shower/bath mixer external parts for CS 800 with 3 outlet shut-off valve and metal plate

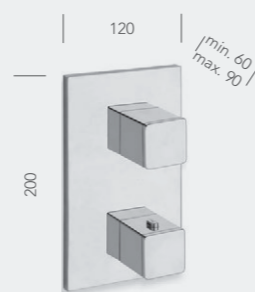

XQ 753

Set da esterno per miscelatore termostatico doccia/vasca CS 800 con valvola d'arresto 3 uscite e piastra in metallo

_Thermostatic shower/bath mixer external parts for CS 800 with 3 outlet shut-off valve and metal plate

THERMOSTATIC MIXERS & COLUMNS



TE 451

Miscelatore termostatico "corpo freddo" per doccia esterno con maniglie in metallo

"Cold touch" external thermostatic shower mixer with metal handle

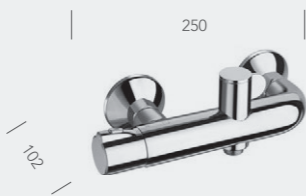

TE 411

Miscelatore termostatico "corpo freddo" per doccia esterno con maniglie in ABS

"Cold touch" external thermostatic shower mixer with ABS handle



TE 458

Miscelatore termostatico "corpo freddo" per doccia esterno con maniglie in ABS, colonna girevole, soffione SANDWICH SPECIAL ø 25 cm, doccetta anticalcare con supporto scorrevole e flessibile LONG LIFE

"Cold touch" external thermostatic shower mixer with ABS handle, turning column pipe, ø 25 cm SANDWICH SPECIAL overhead shower, anti-lime hand shower with slide rail and LONG LIFE flexible hose



QS 409

Miscelatore monocomando per doccia esterno con colonna girevole, soffione SANDWICH SPECIAL 25 x 25 cm, doccetta anticalcare con supporto scorrevole e flessibile LONG LIFE

"Cold touch" external thermostatic shower mixer with turning column pipe, 25 x 25 cm SANDWICH SPECIAL overhead shower, anti-lime hand shower with slide rail and LONG LIFE flexible hose



CN 409

Miscelatore bicomando per doccia esterno con soffione anticalcare ispezionabile, flessibile e doccetta anticalcare con supporto scorrevole

External shower mixer with checkable anti-lime overhead shower, flexible hose and anti-lime hand shower with slide rail



LD 486

Miscelatore bicomando per doccia esterno con soffione anticalcare ispezionabile, flessibile e doccetta anticalcare con supporto scorrevole

External shower mixer with checkable anti-lime overhead shower, flexible hose and anti-lime hand shower with slide rail



TE 494

Miscelatore termostatico "corpo freddo" per doccia esterno con maniglie in metallo, colonna girevole, soffione ø 25 cm, doccetta 3 funzioni anticalcare con supporto scorrevole e flessibile LONG LIFE. Nero opaco

"Cold touch" external Thermostatic shower mixer with metal handle, turning column pipe, ø 25 cm overhead shower, multi-jet anti-lime hand shower with slide rail and LONG LIFE flexible hose. Black mat

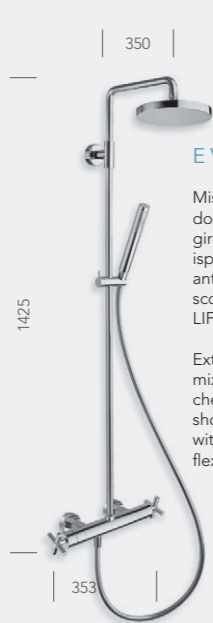

EV 456

Miscelatore termostatico per doccia esterno con colonna girevole, soffione anticalcare ispezionabile, doccetta anticalcare con supporto scorrevole e flessibile LONG LIFE

External thermostatic shower mixer with turning column pipe, checkable anti-lime overhead shower, anti-lime hand shower with slide rail and LONG LIFE flexible hose

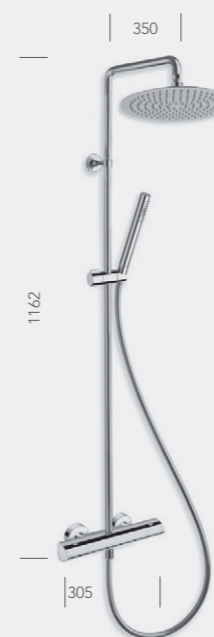

PF 486

Miscelatore termostatico "corpo freddo" per doccia esterno con colonna girevole, soffione SANDWICH SPECIAL ø 25 cm, doccetta anticalcare con supporto scorrevole e flessibile LONG LIFE

"Cold touch" external thermostatic shower mixer with turning column pipe, ø 25 cm SANDWICH SPECIAL overhead shower, anti-lime hand shower with slide rail and LONG LIFE flexible hose

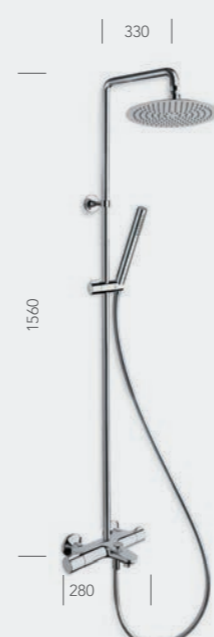

TE 180

Miscelatore termostatico "corpo freddo" per vasca esterno con maniglie in ABS, colonna girevole, soffione SANDWICH SPECIAL ø 20 cm, doccetta anticalcare con supporto scorrevole e flessibile LONG LIFE

"Cold touch" external thermostatic bath mixer with ABS handle, turning column pipe, ø 25 cm SANDWICH SPECIAL overhead shower, anti-lime hand shower with slide rail and LONG LIFE flexible hose



QD 188

Miscelatore termostatico "corpo freddo" per vasca esterno con colonna girevole, soffione SANDWICH SPECIAL 25 x 25 cm, doccetta anticalcare e flessibile LONG LIFE

"Cold touch" external thermostatic bath mixer with turning column pipe, 25 x 25 cm SANDWICH SPECIAL overhead shower, anti-lime hand shower and LONG LIFE flexible hose



TR 104 CN

Miscelatore termostatico "corpo freddo" per vasca esterno con colonna girevole, soffione SANDWICH SPECIAL 25 x 25 cm, doccetta anticalcare e flessibile LONG LIFE

"Cold touch" external thermostatic bath mixer with turning column pipe, 25 x 25 cm SANDWICH SPECIAL overhead shower, anti-lime hand shower and LONG LIFE flexible hose

DYNAMO, SANDWICH & SHOWERHEADS

Ø 300



PD 028

Soffione anticalcare autoalimentato DYNAMO RAINBOW ø 30 cm con illuminazione a led 7 colori

_Self-powered shower head DYNAMO RAINBOW ø 30 cm with anti-lime system and 7 colours led light - without electrical power supply

340

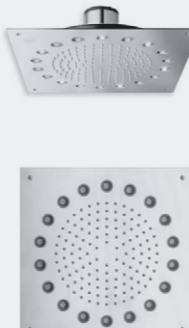

PD 368

Soffione anticalcare autoalimentato DYNAMO RAINBOW quadrato 34 x 34 cm per fissaggio a soffitto con illuminazione a led 7 colori

_Ceiling mounting self-powered shower head DYNAMO RAINBOW 34 x 34 cm squared with anti-lime system and 7 colours led light - without electrical power supply

Ø 300
Ø 400
Ø 500
Ø 600

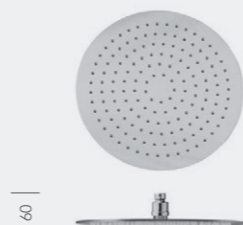

PD 001 | PD 002 | PD 003 | PD004

Soffione anticalcare SANDWICH PLUS

_SANDWICH PLUS anti-lime showerhead



PD 558

Soffione anticalcare ø 30 cm

_ø 30 cm anti-lime showerhead



PD 557

Soffione anticalcare quadrato 30 x 30 cm ispezionabile

_30 x 30 cm checkable square anti-lime showerhead

300 x 300
400 x 400
500 x 500
600 x 600

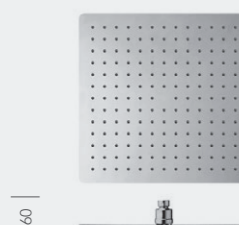

PD 005 | PD 006 | PD 007 | PD008

Soffione anticalcare SANDWICH PLUS quadrato

_Square SANDWICH PLUS anti-lime showerhead

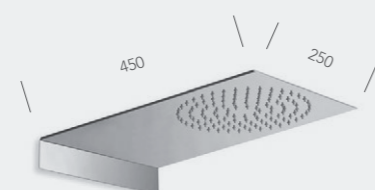

PD 041

Soffione anticalcare SANDWICH PLUS

_SANDWICH PLUS anti-lime showerhead

Ø 300



PD 027

Soffione anticalcare retrò SANDWICH PLUS ø 30 cm

_ø 30 cm retro style SANDWICH PLUS anti-lime showerhead

WATERFALL & BODY JETS



PD 382

Soffione anticalcare con erogazione a cascata integrata e sistema di fissaggio a parete

_Anti-lime showerhead with built-in waterfall flow and wall mounting system

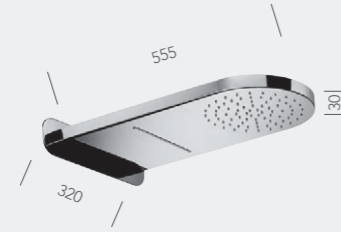

PD 383

Soffione anticalcare con erogazione a cascata integrata e sistema di fissaggio a parete

_Anti-lime showerhead with built-in waterfall flow and wall mounting system

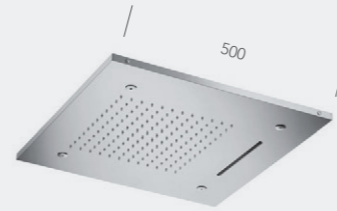

PD 390

Soffione anticalcare quadrato 50 x 50 cm con illuminazione a 11 programmi, erogazione a cascata integrata, nebulizzatore e fissaggio a soffitto

_50 x 50 cm square anti-lime showerhead with 11 programmes lighting, built-in waterfall flow, spray nozzle and ceiling mounting system



XT 833

Set da esterno per soffione anticalcare body-jet CS 705 - CS 706 - CS 707

_Anti-lime body jet external parts for CS 705 - CS 706 - CS 707



XQ 833

Set da esterno per soffione anticalcare body-jet CS 705 - CS 706 - CS 707

_Anti-lime body jet external parts for CS 705 - CS 706 - CS 707



XC 833

Set da esterno per soffione anticalcare body-jet CS 705 - CS 706 - CS 707

_Anti-lime body jet external parts for CS 705 - CS 706 - CS 707



PD 381

Soffione anticalcare quadrato 50 x 50 cm con erogazione a cascata integrata e fissaggio a soffitto

_50 x 50 cm square anti-lime showerhead with built-in waterfall flow and ceiling mounting system



BD 321

Bocca erogazione a cascata da 20 cm per parete

_20 cm wall mounting waterfall spout

SPOUTS

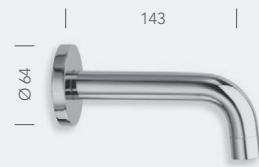

PD 484

Bocca erogazione incasso da 1/2"
_1/2" built in spout

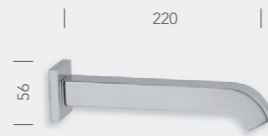

PD 485

Bocca erogazione incasso da 1/2"
_1/2" built in spout

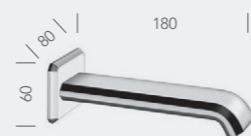

PD 699

Bocca erogazione incasso da 1/2"
_1/2" built in spout



PD 480

Bocca erogazione incasso da 1/2"
_1/2" built in spout

COLUMNS



PD 501

Colonna doccia con deviatore 3+1 uscite, soffione anticalcare ispezionabile, flessibile LONG LIFE, doccetta anticalcare con supporto scorrevole, getti anticalcare orientabili, uscita combinata soffione e getti con alimentazione esterna

Multifunction shower column with 3+1 outlets diverter, checkable anti-lime showerhead, LONG LIFE flexible hose, anti-lime hand shower with slide rail, adjustable anti-lime jets, combined shower head/jets outlet with external supply



PD 069

Asta saliscendi da 100 cm con flessibile LONG LIFE e doccetta anticalcare orientata in ABS

100 cm sliding bar with LONG LIFE flexible hose and ABS skewed anti-lime hand shower



PD 079

Asta saliscendi da 100 cm con flessibile LONG LIFE e doccetta anticalcare in ABS

100 cm sliding bar with LONG LIFE flexible hose and ABS anti-limescale hand shower



PD 066

Asta saliscendi da 54 cm con flessibile e doccetta anticalcare

54 cm sliding bar with flexible hose and anti-limescale hand shower

CRISTINA SYSTEM

GAMMA DI PRODOTTI DA INCASSO REALIZZATI CON OTTONI AVENTI PROPRIETÀ ANTI-DEZINCIFICANTI (ADZ), UNIVERSALI ED UTILIZZABILI CON TUTTI I SET ESTERNI INCLUSI NELLE VARIE LINEE.

_RANGE OF CONCEALED PRODUCTS MADE WITH DEZINCIFICATION RESISTANT (DZR) BRASS, UNIVERSAL AND USABLE WITH ALL EXTERNAL SET INCLUDED IN THE VARIOUS LINES.

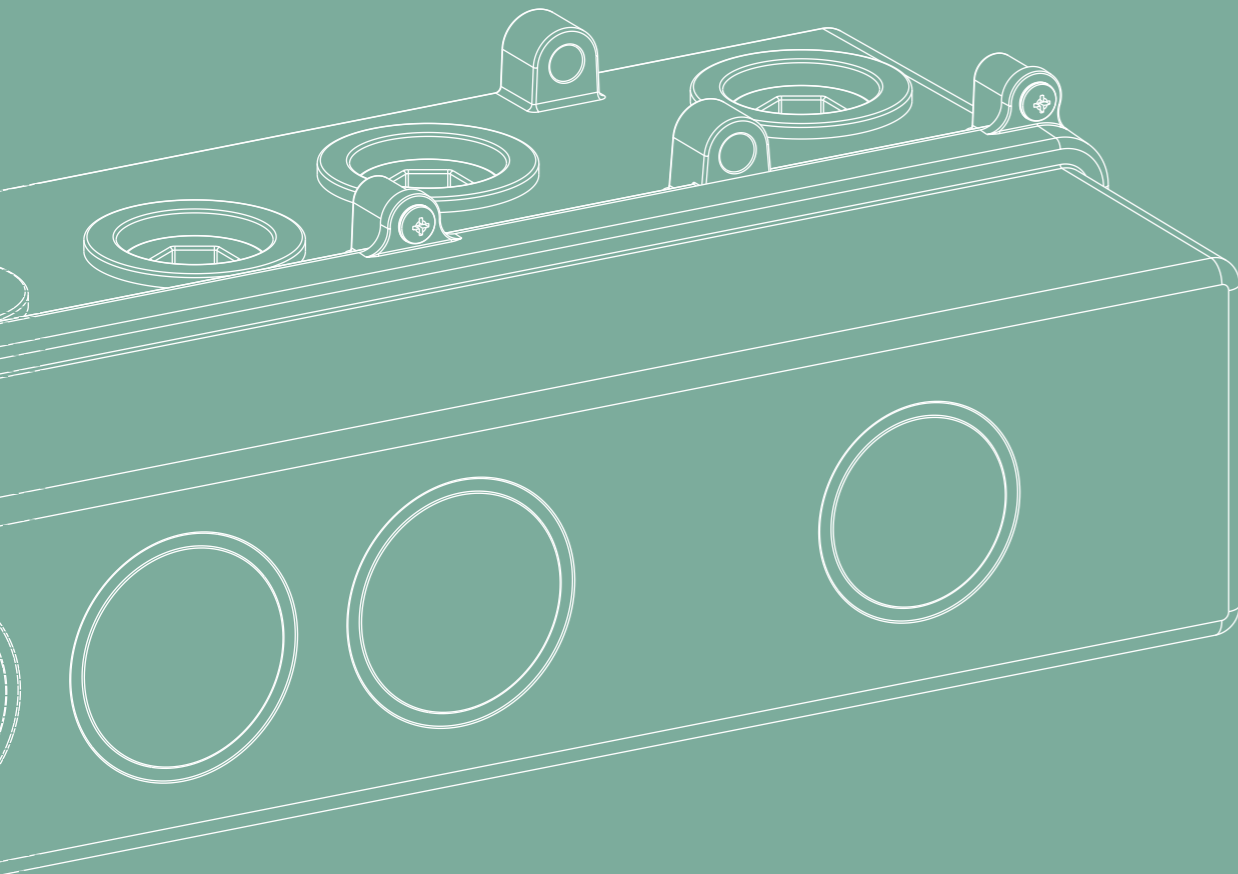

CRISTINA SYSTEM

THE RANGE Technical Specifications

p. 328

p. 332

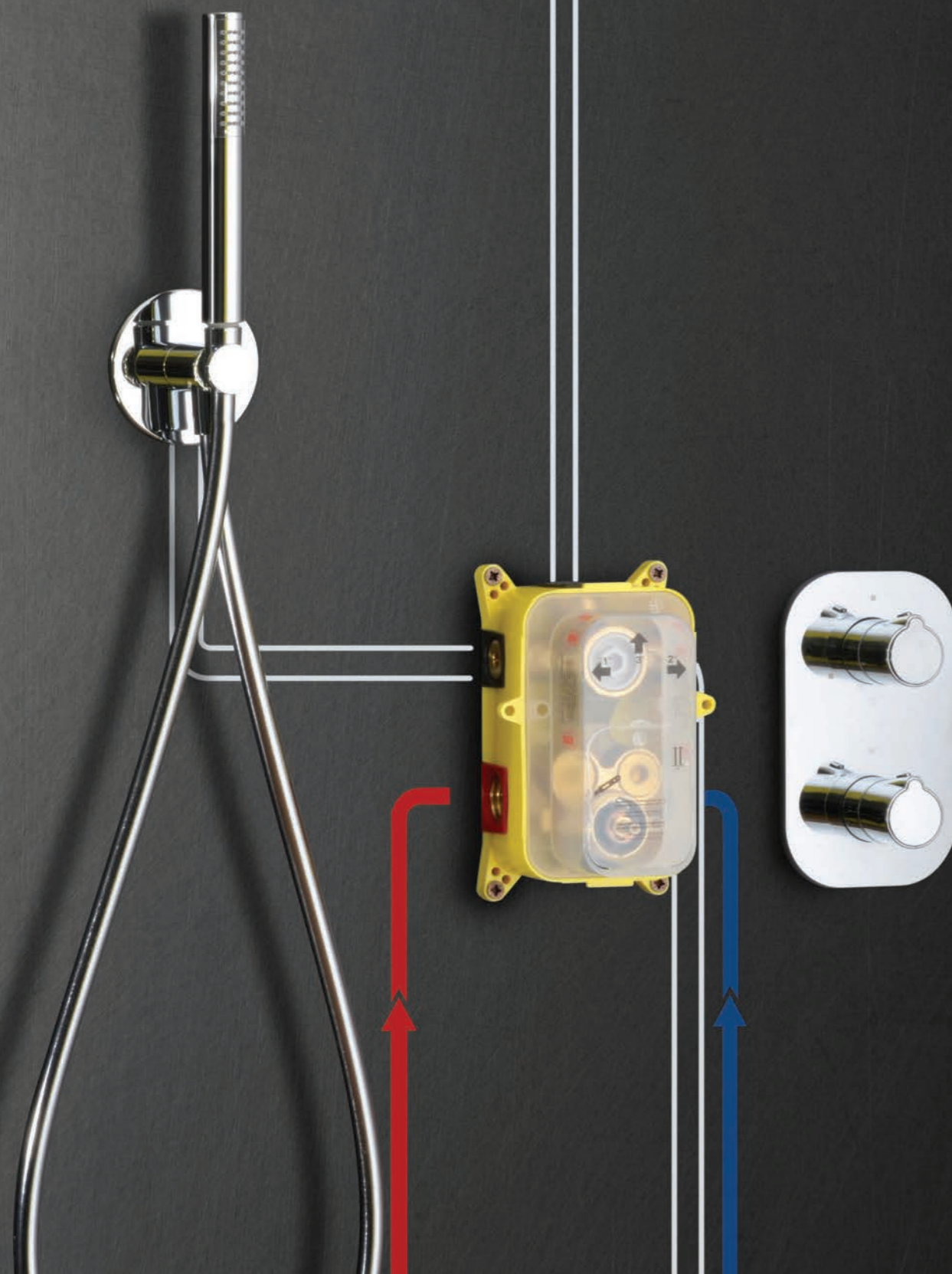

Il mondo CRISTINA System vanta una gamma di prodotti che consente di semplificare notevolmente le procedure di installazione della rubinetteria a incasso per miscelatori termostatici e monocomando, sia per lavabo che per doccia/vasca. I corpi da incasso sono realizzati con ottoni aventi proprietà anti-dezincificanti (ADZ) e caratterizzati da una scatola con sistema impermeabile e asole di fissaggio che consentono l'installazione su strutture prefabbricate. Sono progettati per essere universali ed essere utilizzati con tutti i set esterni inclusi nelle varie linee a catalogo, permettendo composizioni sia orizzontali che verticali.

_The world CRISTINA System offers a wide range of products that can greatly simplify the installation procedures of all the wall mounted taps for shower or bath, thermostatic or standard ones. The concealed bodies are made with dezincification resistant (DZR) brass that come with a box with waterproof system and fixing eyelets that allow installation on prefabricated structures. They are designed to be universal and can be used with all external sets included in the various lines of the general catalogue, offering wider possibilities of combinations for horizontal and vertical solutions.

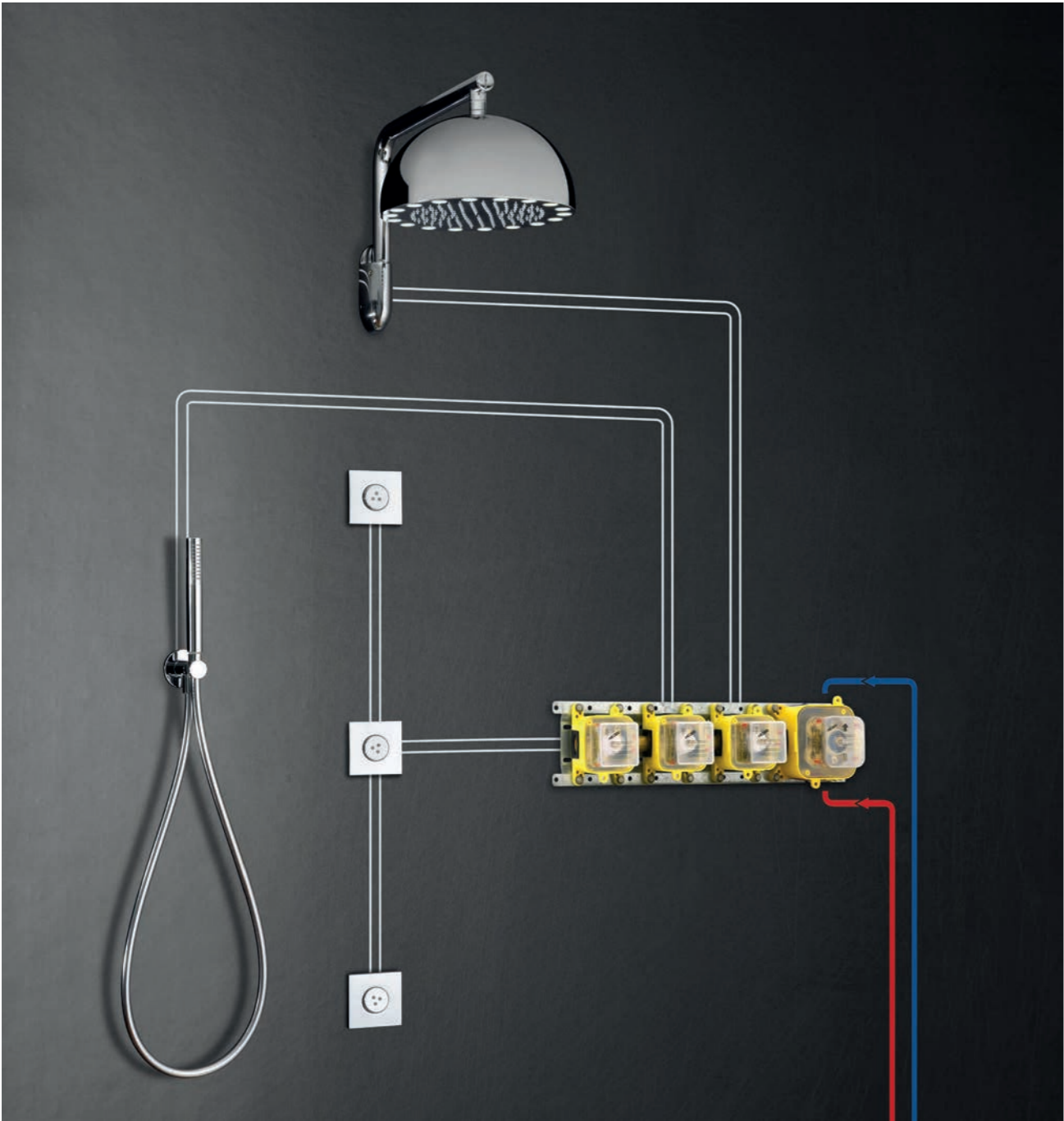

CS 703

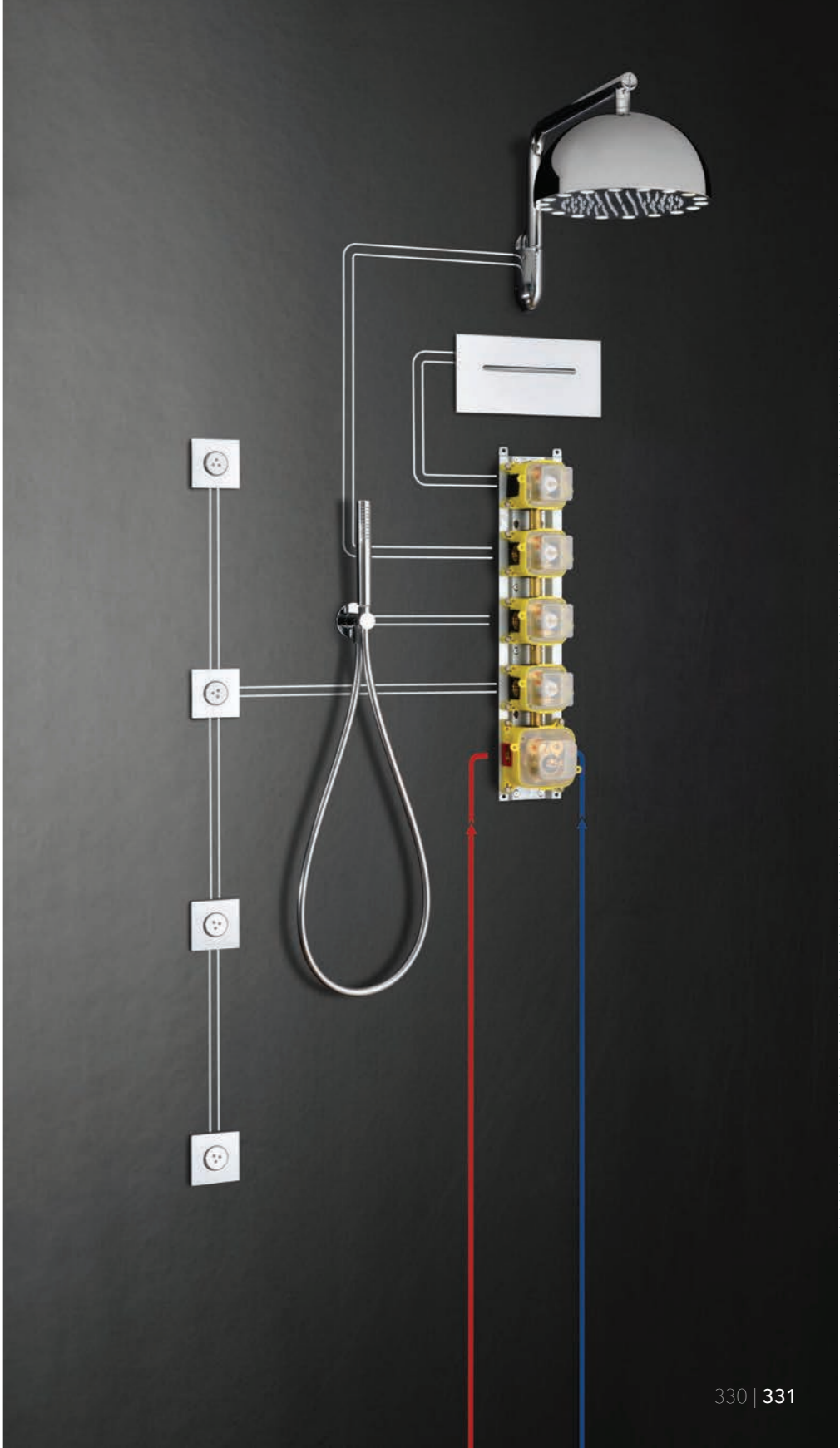

CS 704

CRISTINA SYSTEM

SET DA INCASSO UNIVERSALI
_UNIVERSAL CONCEALED BODIES



CS 100

Set da incasso universale per miscelatore monocomando doccia/vasca con deviatore 2 o 3 uscite - comando destro

_Universal shower/bath concealed body with diverter to 2 or 3 outlets - right side

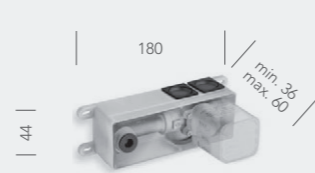

CS 200

Set da incasso universale per miscelatore monocomando lavabo/bidet - comando destro

_Universal basin/bidet concealed body - right side

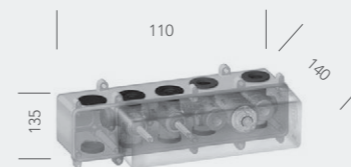

CS 812

Set da incasso universale per miscelatore termostatico THERMO UP doccia/vasca da 1/2" con 2 uscite da 1/2"

_1/2" THERMO UP universal thermostatic shower/bath concealed body with 2 outlets 1/2"



CS 704

Set da incasso universale e premontato per miscelatore termostatico da 3/4", con 4 valvole d'arresto indipendenti da 1/2"

_3/4" universal thermostatic concealed body with 4 independent 1/2" stopcocks - pre-assembled

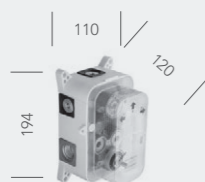

CS 800

Set da incasso universale per miscelatore termostatico doccia/vasca da 3/4" con 1 o 2 o 3 uscite da 1/2"

_3/4" universal thermostatic shower/bath concealed body with option of 1 or 2 or 3 outlets 1/2"

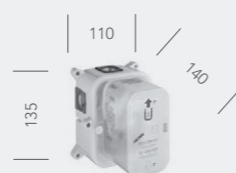

CS 535

Set da incasso universale per miscelatore monocomando doccia/vasca con 1 o 2 uscite da 1/2"

_Universal shower/bath concealed body with option of 1 or 2 outlets 1/2"

WATER SYSTEMS

40 ANNI DI ESPERIENZA PORTANO SILFRA A DIVENTARE LEADER DI SETTORE, OFFRENDO UN'AMPIA GAMMA DI PRODOTTI DALL'ELEVATA QUALITÀ TECNICA ED ESTETICA.

_WITH ITS 40 YEARS OF EXPERIENCE, SILFRA HAS BECOME LEADER IN THE INDUSTRY, THE WIDE RANGE OFFERS PRODUCTS OF HIGH TECHNICAL AND AESTHETIC QUALITY.

ELECTRONIC TAPS	p.336
PUSH TAPS	p.340
CLINIC TAPS	p.344
BASIN WASTES	p.348
PASSEPARTOUT	p.352
FOLLOW ME	p.356
SHOWER DRAINS	p.360
BATH WASTES	p.364
THE RANGE Technical Specifications	p.368

ELECTRONIC TAPS

I rubinetti elettronici hanno un sistema di erogazione temporizzata, preregolata a 30" con portata di 6 l/min a 3 Bar.

_The electronic taps have a timed flow system, pre-set to 30" with flow rate 6 L/min at 3 Bar.

QT 332



QT 862



QT 230



PUSH TAPS

I rubinetti temporizzati per lavabo e doccia comprendono le serie QUIK5 corredata di regolatore di portata dell'acqua e QUIK4 corredata di regolatore di tempo di utilizzo, portata e temperatura dell' acqua.

_The basin and showers taps include the QUIK5 range equipped with flow rate control and the QUIK4 range equipped with time regulator, flow rate and water temperature control.



QT 532



Q5 230



CLINIC



Una selezione di rubinetteria temporizzata dalle molteplici applicazioni sia in ambiente privato che pubblico.

_A selection of time taps providing multiple applications in both a private and public environment.



LC 221

QL 230



QL 100



BASIN WASTES

La linea scarichi per lavabo Up&Down in ottone e plastica ha completamente rivoluzionato l'interpretazione dei complementi d'arredo per l'ambiente bagno. Svincolata dal comando del rubinetto, l'apertura e la chiusura del bacino d'acqua avviene a scatto con una leggera pressione della mano sul tappo nella versione Up&Down; rimane sempre aperto nella versione a scarico libero. La serie Up&Down si declina in una vasta gamma di accessori che ne agevolano l'installazione sui lavabi.

_The Up&Down waste series has completely changed the way of thinking about the sanitaryware fittings. Not linked to the faucet, the opening and closing system runs easily, with a soft touch on the plug top (the free flow version remains open). The Up&Down mechanism comes with a complete range of accessories to make installation easier than ever.

UD 425 S





AC 393



UD 150 S

PASSEPARTOUT

Passepartout è in grado di risolvere ogni tipo di collegamento in caso di disassamento tra il foro del lavello e lo scarico a parete o a pavimento. Può raccordarsi ad ogni tipo di piletta e di sifone. Grazie alla sua flessibilità può assumere forme e lunghezze desiderate. Passepartout è un tubo corrugato realizzato in acciaio inox ed è disponibile nella versione ø 32 mm e ø 41 mm con finiture: cromo, satinato e grezzo.

_Passepartout is designed to resolve any connection type in case of misalignment between the washbasin and wall or floor waste hole. It can be connected to every type of waste or siphon. Thanks to its flexibility, it can be adapted to the desired shape and length. Passepartout is a stainless steel corrugated pipe available in ø 32 mm and ø 41 mm with finishings: chrome, brushed and "yellow" untreated.





PP 610



PP 610

FOLLOW ME

Supporto bordo vasca FOLLOW ME con sgocciolatoio drenante.
La presenza di una molla in acciaio inox facilita il rientro in automatico del flessibile.

_Deck mounted FOLLOW ME bracket with drip draining kit.
The stainless steel spring helps the flexible hose automatic retractable return.





PP 467

SHOWER DRAINS

Piletta sifonata per piatto doccia, ispezionabile.

_Shower drain checkable.

AD 400



AD 200



AD 305



BATH WASTES



V1 85 00



U1



D6

ELECTRONIC TAPS

the range

LAVABO - BIDET

_WASHBASIN - BIDET



QT 332

Rubinetto elettronico per lavabo

_Electronic tap for wash basin



QT 232

Rubinetto elettronico per lavabo

_Electronic tap for wash basin



QT 233

Rubinetto elettronico per lavabo

_Electronic tap for wash basin



QT 862

Rubinetto elettronico a incasso per lavabo

_Concealed electronic tap for wash basin



QT 350

Rubinetto elettronico per lavabo

_Electronic tap for wash basin



QT 340

Rubinetto elettronico per lavabo

_Electronic tap for wash basin



QT 207

Rubinetto elettronico per lavabo

_Electronic tap for wash basin



QT 730

Rubinetto elettronico per lavabo

_Electronic tap for wash basin



QT 731

Rubinetto elettronico per lavabo

_Electronic tap for wash basin



QT 872

Rubinetto elettronico a incasso per doccia

_Concealed electronic tap for shower



QT 820

Rubinetto elettronico a incasso per orinatoio

_Concealed electronic tap for urinal

* interasse corpo - bocca

PUSH TAPS

the range

LAVABO - BIDET
_WASHBASIN - BIDET



Q4 232

Rubinetto temporizzato per lavabo

_Wash basin push tap



Q4 252

Rubinetto temporizzato per lavabo

_Wash basin push tap



Q5 232

Rubinetto temporizzato per lavabo

_Wash basin push tap



Q4 532

Rubinetto temporizzato per lavabo a incasso

_Concealed wash basin push tap



Q4 165

Rubinetto temporizzato per doccia esterno a 2 vie

_External shower push tap - 2 way

CLINIC the range

LAVABO - BIDET
_WASHBASIN - BIDET

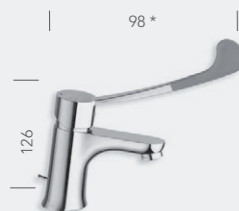

LC 221

Miscelatore monocomando REGULAR per lavabo con scarico da 1"1/4 e asta comando

_Basin mixer REGULAR with 1"1/4 pop up waste



LC 231

Miscelatore monocomando REGULAR per lavabo con doccia estraibile monogetto senza scarico

_Basin mixer REGULAR with pull-out spray without pop up

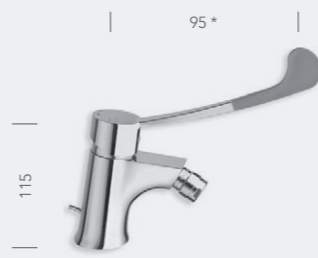

LC 321

Miscelatore monocomando REGULAR per bidet con scarico da 1"1/4 e asta comando

_Bidet mixer REGULAR with 1"1/4 pop up waste

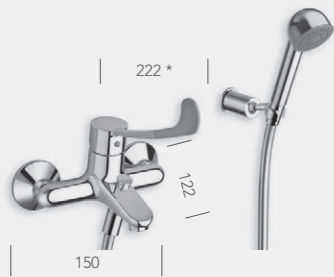

LC 101

Miscelatore monocomando per vasca esterno con flessibile LONG LIFE e doccia anticalcare orientabile

_External bath mixer with LONG LIFE flexible hose and adjustable anti-lime hand shower



LC 403

Miscelatore monocomando per doccia esterno con flessibile LONG LIFE e doccia anticalcare orientabile con chiusura

_External shower mixer with LONG LIFE flexible hose and adjustable anti-lime hand shower

* interasse corpo - bocca

QUIK the range



QL 230

Rubinetto temporizzato per lavabo con leva a gomito

_Rubinetto temporizzato per lavabo con leva a gomito



QL 235

Rubinetto temporizzato per lavello a canale con leva a gomito

_Wall mounted basin tap with elbow lever



QL 100

Rubinetto temporizzato per sottolavabo a 1 via con leva a ginocchio

_Under basin tap with knee lever



AT 961

Bocca per lavabo in tubo ottone ø 25 mm con aeratore attacco da 1/2"

_ø 25 mm brass basin spout with aerator - 1/2" connection



AT 962

Bocca a muro in tubo ottone ø 25 mm con aeratore attacco da 1/2"

_ø 25 mm brass wall spout with aerator - 1/2" connection



AT 963

Bocca girevole per lavabo in tubo ottone ø 25 mm con aeratore attacco da 1/2"

_ø 25 mm swivel brass basin spout with aerator - 1/2" connection



QK 400

Rubinetto elettronico a incasso per doccia

_Concealed electronic tap for shower



QK 420

Rubinetto elettronico a incasso per orinatoio

_Concealed electronic tap for urinal



QK 450

Rubinetto elettronico a incasso per orinatoio

_Concealed electronic tap for urinal



AT 964

Bocca girevole per lavabo in tubo ottone ø 25 mm con aeratore attacco da 1/2"

_ø 25 mm swivel brass basin spout with aerator - 1/2" connection



AT 965

Bocca girevole per lavabo in tubo ottone ø 18 mm con aeratore attacco da 1/2"

_ø 18 mm swivel brass basin spout with aerator - 1/2" connection

* interasse corpo - bocca

FLUSH VALVE

the range



QK 800

Flussometro esterno con raccordo antiriflusso

_External flush valve with non-return joint n



QK 805

Flussometro esterno

_External flush valve



QK 822

Flussometro ad incasso con raccordo antiriflusso

_Concealed flush valve with non-return joint n

BASIN WASTES

the range



UD 810 S

Scarico per lavabo 1"1/4 con troppo pieno

_1"1/4 basin waste with overflow



UD 830 S

Scarico per lavabo 1"1/4 con troppo pieno

_1"1/4 basin waste with overflow 60/75/100 mm



UD 831 S

Scarico per lavabo 1"1/4 con troppo pieno

_1"1/4 basin waste with overflow 60/75/100 mm



UD 369 S

Scarico per lavabo 1"1/4 con troppo pieno

_1"1/4 basin waste with overflow
60/75/100 mm

UD 440 S

Scarico per lavabo 1"1/4 con troppo pieno

_1"1/4 basin waste with overflow
60/75/100 mm

UD 425 S

Scarico per lavabo 1"1/4 universale

_ Universal 1"1/4 basin waste



UD 970

Scarico per lavabo 1"1/4 con troppo pieno

_1"1/4 basin waste with overflow
60/75/100 mm

UD 971

Scarico per lavabo 1"1/4 con troppo pieno

_1"1/4 basin waste with overflow
60/75/100 mm

UD 389 S

Scarico per lavabo 1"1/4 con troppo pieno

_1"1/4 basin waste with overflow
60/75/100 mm

UD 225 S

Scarico per lavabo 1"1/4 universale

_ Universal 1"1/4 basin waste



UD 309

Scarico per lavabo 1"1/4 senza troppo pieno

_1"1/4 basin waste without overflow
35/60/75/100 mm

UD 380

Scarico per lavabo 1"1/4 senza troppo pieno

_1"1/4 basin waste without overflow
60/75/100 mm

UP&DOWN

the range

SCARICO
_BASIN WASTE



UD 525

Scarico per lavabo 1"1/4 universale

_ Universal 1"1/4 basin waste



UD 119

Scarico per lavabo 1"1/4 con griglia

_ 1"1/4 basin waste with grid



UD 435 S

Scarico per lavabo 1"1/4 universale

_ Universal 1"1/4 basin waste



UD 526

Scarico per lavabo 1"1/2

_ Universal 1"1/2



UD 364

Scarico per lavabo 1"1/2

_ Universal 1"1/2



WA 334 S

Scarico per lavabo 1"1/4 universale

_ Universal 1"1/4 basin waste



UD 535

Scarico per lavabo 1"1/4 universale

_ Universal 1"1/4 basin waste



UD 426 S

Scarico per lavabo 1"1/2

_ Universal 1"1/2



UD 370

Scarico per lavabo 1"1/2

_ Universal 1"1/2



WA 320 S | WA 420 S

Scarico per lavabo 1"1/4 universale 64/72 mm

_ Universal 1"1/4 basin waste



WA 111 S

Scarico per lavabo 1"1/4 universale 64/72 mm

_ Universal 1"1/4 basin waste



UD 850 S

Scarico per lavabo 1"1/4 universale

_ Universal 1"1/4 basin waste



UP&DOWN

the range

SCARICO
_BASIN WASTE



WF 434

Scarico per lavabo 1"1/4 universale

_ Universal 1"1/4 basin waste



WF 420

Scarico per lavabo 1"1/4 universale

_ Universal 1"1/4 basin waste



WF 211

Scarico per lavabo 1"1/4 universale

_ Universal 1"1/4 basin waste



UD 950

Scarico per lavabo 1"1/4 universale

_ Universal 1"1/4 basin waste

UP&DOWN

the range

SCARICO COMPLETO DI SIFONE
_COMPLETE WASTE WITH SIPHON



UD 417 S | UD 413 S

Con troppo pieno/senza troppo pieno

_With overflow/without overflow



UD 617 S | UD 613 S

Con troppo pieno/senza troppo pieno

_With overflow/without overflow



UD 677 S | UD 673 S

Con troppo pieno/senza troppo pieno

_With overflow/without overflow



UD 150 S | UD 152 S | UD 153 S

Piletta universale - Tappo ø 64/72 mm Up&Down

_Universal waste - ø 64 mm Up&Down plug



UD 151

Piletta universale - Tappo ø 72 mm

_Universal waste - ø 72 mm plug



AC 393

Sifone per lavabo in ottone 1"1/4

_1"1/4 brass basin siphon



UD 423

Senza troppo pieno

_Without overflow



UD 623

Senza troppo pieno

_Without overflow



UD 683

Senza troppo pieno

_Without overflow

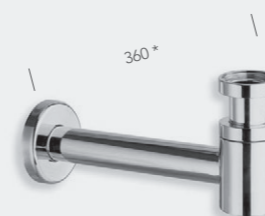

AC 394

Sifone per bidet in ottone 1"1/4

_1"1/4 brass bidet siphon



AC 790

Sifone per lavabo in plastica 1"1/4

_1"1/4 plastic basin siphon

* interasse corpo - bocca

PASSEPARTOUT

the range

PER RACCORDO A PILETTE LAVABO
_FOR WASTE JOINT WASH BASIN

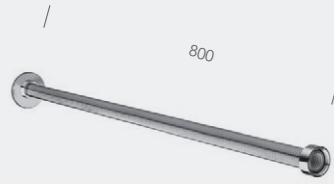

PP 130

Tubo corrugato \varnothing 32 mm con uscita attacco \varnothing 32 mm oppure \varnothing 40 mm. Lunghezza 800 mm.

_ \varnothing 32 mm flexible pipe with \varnothing 32 mm or \varnothing 40 mm connection.
Length 800 mm.

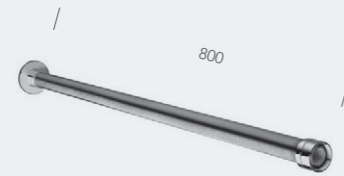

PP 230

Tubo corrugato \varnothing 41 mm con uscita attacco \varnothing 32 mm oppure \varnothing 40 mm. Lunghezza 800 mm.

_ \varnothing 41 mm flexible pipe with \varnothing 32 mm or \varnothing 40 mm connection.
Length 800 mm.

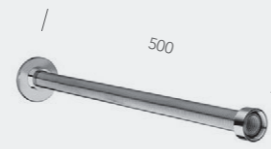

PP 610

Tubo corrugato \varnothing 32 mm con uscita attacco \varnothing 32 mm oppure \varnothing 40 mm. Lunghezza 500 mm.

_ \varnothing 32 mm flexible pipe with \varnothing 32 mm or \varnothing 40 mm connection.
Length 500 mm.

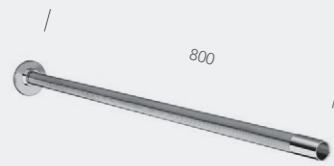

PP 131

Tubo corrugato \varnothing 32 mm con uscita attacco \varnothing 32 mm oppure \varnothing 40 mm. Lunghezza 800 mm.

_ \varnothing 32 mm flexible pipe with \varnothing 32 mm or \varnothing 40 mm connection.
Length 800 mm.

FOLLOW ME

the range

DISPOSITIVO
_THE DEVICE



PD 466

Supporto bordo vasca FOLLOW ME con sgocciolatoio
drenante - rosone conico

_Deck mounted FOLLOW ME bracket with drip draining
kit Conical cover plate



PD 467

Supporto bordo vasca FOLLOW ME con sgocciolatoio
drenante - rosone tondo

_Deck mounted FOLLOW ME bracket with drip draining
kit Round cover plate



PD 468

Supporto bordo vasca FOLLOW ME con sgocciolatoio
drenante - rosone quadro

_Deck mounted FOLLOW ME bracket with drip draining
kit Square cover plate

SHOWER DRAINS

the range



AD 400 | AD 450

Piletta sifonata per piatto doccia ispezionabile, uscita con calotta \varnothing 40 mm - foro piatto doccia \varnothing 90 mm - tappo \varnothing 120 mm

_Shower drain with removable siphon, outlet with connecting nut \varnothing 40 mm - shower tray hole \varnothing 90 mm - drain cover \varnothing 120 mm



AD 410 | AD 455

Piletta sifonata per piatto doccia ispezionabile, uscita con calotta \varnothing 40 mm - foro piatto doccia \varnothing 90 mm - tappo \varnothing 120 mm

_ Shower drain with removable siphon, outlet with connecting nut \varnothing 40 mm - shower tray hole \varnothing 90 mm - drain cover \varnothing 120 mm



AD 420 | AD 470

Piletta sifonata per piatto doccia ispezionabile, uscita con calotta \varnothing 40 mm - foro piatto doccia \varnothing 90 mm - senza tappo

_Shower drain with removable siphon, outlet with connecting nut \varnothing 40 mm - shower tray hole \varnothing 90 mm - without drain cover



AD 885 | AD 895

Piletta sifonata per piatto doccia ispezionabile, uscita emisferica snodata con calotta \varnothing 40 mm - foro piatto doccia \varnothing 90 mm - tappo \varnothing 120 mm

_Shower drain with removable siphon, outlet with ball joint connecting nut \varnothing 40 mm - shower tray hole \varnothing 90 mm - drain cover \varnothing 120 mm



AD 500 | AD 550

Piletta sifonata per piatto doccia ispezionabile, uscita con calotta \varnothing 40 mm - foro piatto doccia \varnothing 90 mm - tappo \varnothing 120 mm

_Shower drain with removable siphon, outlet with connecting nut \varnothing 40 mm - shower tray hole \varnothing 90 mm - drain cover \varnothing 120 mm



AD 505 | AD 555

Piletta sifonata per piatto doccia ispezionabile, uscita emisferica snodata con calotta \varnothing 40 mm - foro piatto doccia \varnothing 90 mm - tappo \varnothing 120 mm

_Shower drain with removable siphon, outlet with ball joint connecting nut \varnothing 40 mm - shower tray hole \varnothing 90 mm - drain cover \varnothing 120 mm



AD 300 | AD 350

Piletta sifonata per piatto doccia ispezionabile, uscita con calotta \varnothing 40 mm - foro piatto doccia \varnothing 90 mm - tappo \varnothing 120 mm

_Shower drain with removable siphon, outlet with connecting nut \varnothing 40 mm - shower tray hole \varnothing 90 mm - drain cover \varnothing 120 mm



AD 305 | AD 355

Piletta sifonata per piatto doccia ispezionabile, uscita emisferica snodata con calotta \varnothing 40 mm - foro piatto doccia \varnothing 90 mm - tappo \varnothing 120 mm

_Shower drain with removable siphon, outlet with ball joint connecting nut \varnothing 40 mm - shower tray hole \varnothing 90 mm - drain cover \varnothing 120 mm



AD 880 | AD 890

Piletta sifonata per piatto doccia ispezionabile, uscita con calotta \varnothing 40 mm - foro piatto doccia \varnothing 90 mm - tappo \varnothing 120 mm

_Shower drain with removable siphon, outlet with connecting nut \varnothing 40 mm - shower tray hole \varnothing 90 mm - drain cover \varnothing 120 mm



AD 520 | AD 530

Piletta sifonata per piatto doccia ispezionabile, uscita con calotta \varnothing 40 mm - foro piatto doccia \varnothing 90 mm - tappo \varnothing 120 mm

_Shower drain with removable siphon, outlet with connecting nut \varnothing 40 mm - shower tray hole \varnothing 90 mm - drain cover \varnothing 120 mm



AD 525 | AD 535

Piletta sifonata per piatto doccia ispezionabile, uscita emisferica snodata con calotta \varnothing 40 mm - foro piatto doccia \varnothing 90 mm - tappo \varnothing 120 mm

_Shower drain with removable siphon, outlet with ball joint connecting nut \varnothing 40 mm - shower tray hole \varnothing 90 mm - drain cover \varnothing 120 mm



AD 200 | AD 250

Piletta sifonata per piatto doccia ispezionabile. Uscita con calotta \varnothing 40 mm - Foro piatto doccia \varnothing 50-55 mm - Tappo \varnothing 86 mm.

_New drainage for shower plate, and inspectable. Connection for pipe fitting \varnothing 40 mm - shower plate hole \varnothing 50-55 mm - plug \varnothing 86 mm

SHOWER DRAINS

the range

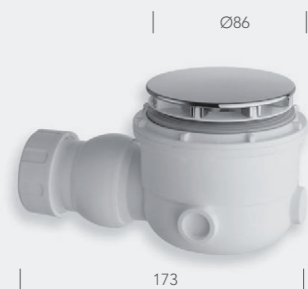

AD 205 | AD 255

Piletta sifonata per piatto doccia ispezionabile.
Uscita con calotta \varnothing 40 mm -
Foro piatto doccia \varnothing 50-55 mm - Tappo \varnothing 86 mm.

_New drainage for shower plate, and inspectable.
Connection for pipe fitting
 \varnothing 40 mm - shower plate hole \varnothing 50-55 mm - plug \varnothing 86 mm



AD 730

Piletta di scarico sifonata in PP, attacco con calotta
 \varnothing 40 mm con griglia in ottone \varnothing 80 mm.

_PP shower drain \varnothing 40mm connection with \varnothing 80 mm
brass grid



AD 590

Piletta di scarico in PP, attacco con calotta \varnothing 40 mm
G.1"1/2, con tappo in ottone \varnothing 72 mm

_PP shower drain, \varnothing 40 mm connection G.1"1/2
with \varnothing 72 mm brass plug



AD 580

Piletta di scarico in PP, attacco con calotta \varnothing 40 mm
G.1"1/2, con griglia inox \varnothing 80 mm

_PP shower drain, \varnothing 40 mm connection G.1"1/2
with \varnothing 72 mm brass plug

BATH WASTES

the range



MOD. 04

Scarico per vasca in polipropilene cm. 47,5. ø 34 mm. Tubo telescopico. Movimento a cremagliera. Certificato a norme NF - DIN. Prodotto secondo le norme EN 274.

_Polypropylene pop up bathtub waste 47,5 cm. ø 34 mm. Telescopic pipe. Rack mechanism. NF-DIN approved. Compliant with EN274.



MOD. 06

Scarico per vasca in polipropilene cm. 47,5. ø 34 mm. Tubo unico. Movimento a cremagliera. Certificato a norme NF - DIN. Prodotto secondo le norme EN 274.

_Polypropylene pop up bathtub waste 47,5 cm. ø 34 mm. One-piece pipe. Rack mechanism. NF-DIN approved. Compliant with EN274.



M1

Scarico per vasca in ottone e rame. Tubo corrugato in rame ø 34 mm. Movimento a cremagliera.

_Brass and copper pop up bath tub waste. ø 34 mm copper pipe. Rack mechanism.



MOD. D6

Scarico per vasca in polipropilene con erogazione al troppo pieno. Tubo telescopico corrugato in polipropilene ø 34 mm. Movimento a cremagliera.

_Polypropylene pop up bathtub waste with supply at overflow. ø 34 mm flexible telescopic pipe. Rack mechanism. Possible to install also on whirlpools.



U1

Scarico per vasca in polipropilene con erogazione al troppo pieno. Tubo corrugato in polipropilene ø 34 mm. Movimento Up&Down

_Polypropylene pop up bathtub waste with supply at overflow. ø 34 mm flexible pipe. Up&Down mechanism



U2

Scarico per vasca in polipropilene. Tubo corrugato in polipropilene ø 34 mm. Movimento Up&Down

_Polypropylene pop up bathtub waste. ø 34 mm flexible pipe. Up&Down mechanism



MOD. A4

Scarico per vasca in polipropilene con erogazione al troppo pieno. Tubo corrugato in polipropilene ø 34 mm. Movimento a cremagliera.

_Polypropylene pop up bathtub waste with supply at overflow. ø 34 mm flexible pipe. Rack mechanism. Possible to install also on whirlpools.



MOD. A6

Scarico per vasca in polipropilene con erogazione al troppo pieno. Tubo corrugato in polipropilene ø 34 mm. Movimento a cremagliera.

_Polypropylene pop up bathtub waste with supply at overflow. ø 34 mm flexible pipe. Rack mechanism. Possible to install also on whirlpools.



MOD. D4

Scarico per vasca in polipropilene con erogazione al troppo pieno. Tubo telescopico corrugato in polipropilene ø 34 mm. Movimento a cremagliera.

_Polypropylene pop up bathtub waste with supply at overflow. ø 34 mm flexible telescopic pipe. Rack mechanism. Possible to install also on whirlpools.



U3 A

Scarico per vasca in polipropilene con troppo pieno nascosto. Tubo semirigido in polipropilene ø 34 mm. Movimento Up&Down.

_Polypropylene pop up bathtub waste with hidden overflow. ø 34 mm semi-rigid pipe. Up&Down mechanism.



U3 1

Scarico per vasca in polipropilene con troppo pieno nascosto. Tubo semirigido in polipropilene ø 34 mm. Movimento con comando delocalizzato.

_Polypropylene pop up bathtub waste with hidden overflow. ø 34 mm semi-rigid pipe. Mechanism with displaced handle.



R6

Scarico per vasca in polipropilene. Tubo corrugato in polipropilene ø 34 mm. Movimento con comando delocalizzato.

_Polypropylene pop up bathtub waste. ø 34 mm flexible pipe. Mechanism with displaced handle.

ACCESSORIES

COORDINATI PER FORME E FINITURE, PERMETTONO DI CREARE UN BAGNO EFFETTO TOTAL LOOK.

_ COORDINATED FOR SHAPES AND FINISHES, THEY ALLOW TO CREATE A BATHROOM WITH A TOTAL LOOK EFFECT.



CONTEMPORARY p.398

INOX p.400

CLASSIC p.401

THE RANGE Technical Specifications p.402



AB 460 13



AB 645 13



AB 406 13 + AB 404 13

AB 606 13 + AB 604 13



AB 460



AB 260



AB 760

ACCESSORIES

CRISTINA

INOX

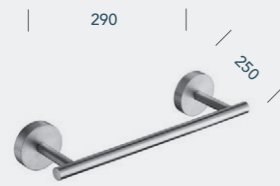

AX 225

Portasalvietta interasse 25 cm

_25 cm centre distance towel rail



AX 230

Portasalvietta interasse 30 cm

_30 cm centre distance towel rail



AX 245

Portasalvietta interasse 45 cm

_45 cm centre distance towel rail



AX 002

Porta sapone a muro in PETG

_Wall mounted PETG soap holder



AX 004

Bicchiere d'appoggio in PETG

_Tumbler



AX 003

Porta sapone d'appoggio in PETG

_Standing PETG soap holder

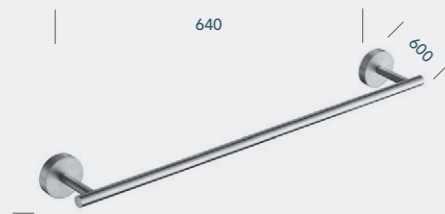

AX 260

Portasalvietta interasse 60 cm

_60 cm centre distance towel rail



AX 201

Appendino

_Hook

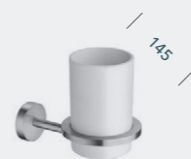

AX 001

Porta bicchiere a muro in PETG

_Wall mounted PETG tumbler holder



AX 040

Maniglione 25 cm

_ Grab-bar 25 cm.

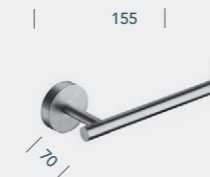

AX 290

Porta rotolo

_Toilet roll holder



AX 030

Porta rotolo di scorta

_Reserve toilet roll holder



AX 050

Porta scopino a pavimento

_Standing toilet brush holder

ACCESSORIES

CRISTINA

CONTEMPORARY



AB 430

Portasalvietta interasse 30 cm - tondo

_30 cm centre distance towel rail - round



AB 445

Portasalvietta interasse 45 cm - tondo

_45 cm centre distance towel rail - round



AB 460

Portasalvietta interasse 60 cm - tondo

_60 cm centre distance towel rail - tondo



AB 400

Porta rotolo - tondo

_Toilet roll holder - round



AB 405

Porta scopino a pavimento

_Standing toilet brush holder

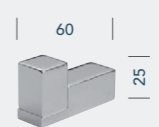

AB 610

Appendino - quadro

_Hook - square

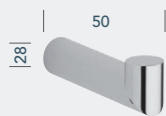

AB 410

Appendino - tondo

_Hook - round



AB 406

Bicchiere d'appoggio

_Tumbler



AB 404

Dispenser sapone d'appoggio

_Standing soap dispenser



AB 630

Portasalvietta interasse 30 cm - quadro

_30 cm centre distance towel rail - square



AB 645

Portasalvietta interasse 45 cm - quadro

_45 cm centre distance towel rail - square



AB 660

Portasalvietta interasse 60 cm - quadro

_60 cm centre distance towel rail - square

ACCESSORIES

CLASSIC



AB 606

Bicchiera d'appoggio - quadro

_Tumbler - square



AB 604

Dispenser sapone d'appoggio - quadro

_Standing soap dispenser - square

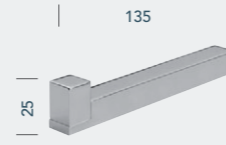

AB 600

Porta rotolo - quadro

_Toilet roll holder - square



AB 605

Porta scopino a pavimento - quadro

_Standing toilet brush holder - square

ACCESSORIES

CLASSIC



AB 730

Portasalvietta interasse 30 cm

_30 cm centre distance towel rail



AB 745

Portasalvietta interasse 45 cm

_45 cm centre distance towel rail



AB 760

Portasalvietta interasse 60 cm

_60 cm centre distance towel rail



AB 704

Dispenser sapone a muro in ceramica

_Wall mounted ceramic soap dispenser



AB 700

Porta rotolo

_Toilet roll holder



AB 705

Porta scopino a pavimento

_Standing toilet brush holder

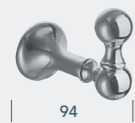

AB 710

Appendino

_Hook



AB 706

Porta bicchiere a muro in ceramica

_Wall mounted ceramic tumbler holder



AB 703

Porta sapone a muro in ceramica

_Wall mounted ceramic soap holder



CRISTINA



SILFRA

CRISTINA S.r.l. a socio unico
via G. Fava, 56
28024 Gozzano (NO) - Italy
phone +39 0322 9545
fax +39 0322 956556
info@cristinagroup.com
cristinarubinetterie.com

Showroom CRISTINA Brera
via Pontaccio, 8/10
20121 Milano - Italy
phone +39 02 83970732
cristinabrera@cristinagroup.com



